

Miltenyi Biotec

# autoMACS® NEO Separator

User manual



Copyright © 2023 Miltenyi Biotec and/or its affiliates. All rights reserved.

No part of this user manual may be reproduced, stored in a retrieval system, transmitted, published, or distributed in any form or by any means, electronically, mechanically, by photocopying, microfilming, recording, or otherwise, without the prior written consent of Miltenyi Biotec; however, notwithstanding the foregoing, the owners of the autoMACS NEO Separator and the MACS MiniSampler S may make copies solely for purposes of training personnel in the use and servicing of the unit within their business or organization. Maximal care has been taken by Miltenyi Biotec in the preparation of this user manual. However, Miltenyi Biotec shall not be liable for any technical or editorial errors or omissions contained herein, or for incidental or consequential damages in connection with the furnishing, performance, or use of this document. The information in this document is provided "as is" without warranty of any kind, and is subject to change without notice. Unless otherwise specifically indicated, Miltenyi Biotec products and services are for research use only and not for therapeutic or diagnostic use. autoMACS, MACS, the Miltenyi Biotec logo, and REAlease are registered trademarks or trademarks of Miltenyi Biotec B.V. & Co. KG and/or its affiliates in various countries worldwide.

# autoMACS<sup>®</sup> NEO Separator

## User manual

Original instructions

Issued: 2023-10

140-005-371.03

autoMACS NEO Software version 1.3 or higher

Miltenyi Biotec B.V. & Co. KG

Friedrich-Ebert-Straße 68

51429 Bergisch Gladbach

Germany

Phone +49 2204 8306-0

Fax +49 2204 85197

[macsde@miltenyi.com](mailto:macsde@miltenyi.com)

[www.miltenyibiotec.com](http://www.miltenyibiotec.com)

# Content

<b>1</b>	<b>Important safety information</b>	<b>9</b>
<b>2</b>	<b>Introduction</b>	<b>17</b>
2.1	The autoMACS NEO Separator	17
2.2	Intended use	17
2.3	Instrument description	18
<b>3</b>	<b>Installation</b>	<b>21</b>
3.1	Components included in the delivery	21
3.2	Consumables	22
3.3	Accessories	23
3.4	Unpacking the autoMACS NEO Separator	23
3.5	Installing the needles	24
3.6	Preparing liquids	25
3.7	Installing the fluid bottles	26
3.8	Installing the MACS MiniSampler S	27
3.9	Connecting the instrument to the power supply	28
<b>4</b>	<b>Setting up the instrument</b>	<b>29</b>
4.1	Switching on	29
4.2	Switching off	29
4.3	Switching into standby	29
4.4	Shutting down	29
4.5	Login	30
4.6	First login	30
4.7	Logout	30
4.8	Calibration	30
4.8.1	Rack calibration	31
4.8.2	Volume calibration	31
4.9	Priming the instrument	32
4.10	Installing autoMACS Columns	32

4.11 Testing the barcode reader .....	34
4.12 The Task planner .....	35
4.12.1 Viewing tasks .....	35
4.12.2 Creating tasks .....	35
<b>5 The user interface .....</b>	<b>37</b>
<b>5.1 Structure .....</b>	<b>37</b>
5.1.1 Title bar .....	38
5.1.2 Menu bar .....	38
5.1.3 Toolbar and currently opened tab .....	39
5.1.4 Message box .....	40
5.1.5 Progress bar .....	40
<b>5.2 The user .....</b>	<b>41</b>
5.2.1 Home tab .....	41
5.2.2 Reagents tab .....	41
5.2.3 Experiments tab .....	42
5.2.4 Tools tab .....	43
5.2.5 Logs tab .....	44
<b>5.3 The administrator .....</b>	<b>44</b>
5.3.1 Settings tab .....	45
5.3.2 Assigning an instrument name .....	45
5.3.3 Installing new software version .....	45
5.3.4 Returning to previous software version .....	46
5.3.5 Setting date and time .....	46
5.3.6 Shortening the experiment time for autolabeling .....	46
<b>6 Setting up an experiment .....</b>	<b>49</b>
<b>6.1 Beginning .....</b>	<b>50</b>
<b>6.2 Defining the separation process .....</b>	<b>50</b>
6.2.1 Autolabeling .....	50
6.2.2 Manual labeling .....	53
<b>6.3 Placing the tubes .....</b>	<b>55</b>

6.3.1 Correct order for placing tubes .....	55
<b>6.4 Function options for setting up an experiment .....</b>	<b>56</b>
6.4.1 Selecting and deselecting sample and reagent positions .....	57
6.4.2 Assigning a reagent to a sample .....	58
6.4.3 Assigning a sample to a reagent .....	59
6.4.4 Scanning reagents .....	61
6.4.5 Copy an assigned separation process to a new sample .....	61
6.4.6 Changing the labeling method .....	62
6.4.7 Setting an incubation time for manual labeling .....	63
6.4.8 Adding lot number and expiration date .....	63
6.4.9 Deleting samples .....	65
6.4.10 Deleting autolabeling reagents .....	65
6.4.11 Deleting manual labeling reagents .....	65
6.4.12 Changing the rack type .....	65
6.4.13 Assigning custom experiment names .....	66
6.4.14 Assigning custom sample names .....	66
<b>6.5 Running an experiment .....</b>	<b>67</b>
<b>6.6 Stopping an experiment .....</b>	<b>67</b>
<b>6.7 Using the Experiment list .....</b>	<b>67</b>
<b>6.8 Using the Reagents tab .....</b>	<b>68</b>
<b>6.9 Exporting a run report .....</b>	<b>68</b>
<b>7 Cell separation .....</b>	<b>71</b>
7.1 Preparing single-cell suspensions .....	71
7.2 Labeling methods .....	71
7.3 Sample volumes .....	71
7.4 Stage loading for samples exceeding the column capacity .....	72
7.5 autoMACS NEO separation programs .....	73
<b>8 Monitoring the instrument .....</b>	<b>75</b>
8.1 Touchscreen LED .....	75
8.2 Fluid bottle illumination .....	75

<b>8.3 Coding of the sample positions</b>	<b>76</b>
<b>8.4 Coding of the reagent positions</b>	<b>76</b>
<b>8.5 Coding of the Experiment list</b>	<b>76</b>
<b>8.6 Coding of the Device check</b>	<b>77</b>
<b>8.7 Messages</b>	<b>77</b>
<b>8.8 Instrument status</b>	<b>78</b>
<b>8.9 Liquid status</b>	<b>78</b>
<b>8.10 Column status</b>	<b>79</b>
<b>9 User management</b>	<b>81</b>
<b>9.1 User management</b>	<b>81</b>
9.1.1 Viewing user accounts	81
9.1.2 Password configuration	81
9.1.3 Setting up user accounts	82
9.1.4 Deactivating user accounts	84
9.1.5 Unlocking user accounts	84
9.1.6 Pre-configured user roles	85
9.1.7 Creating new user roles	85
9.1.8 Modifying user roles	87
9.1.9 Assigning roles to a user account	87
9.1.10 Changing role assignment	88
<b>9.2 Changing passwords</b>	<b>88</b>
<b>10 Cleaning and disinfection</b>	<b>89</b>
<b>10.1 Washing and maintenance programs</b>	<b>89</b>
10.1.1 Rinse	90
10.1.2 QRinse	90
10.1.3 Clean	90
10.1.4 Sleep	90
10.1.5 Store	91
<b>10.2 Surface disinfection</b>	<b>91</b>
<b>10.3 Disinfection of the fluidic system</b>	<b>91</b>

10.3.1 Replacing the columns when the Bleach program is successfully completed .....	92
<b>10.4 Cleaning the needles .....</b>	<b>93</b>
<b>10.5 Cleaning the washing station .....</b>	<b>93</b>
<b>10.6 Cleaning the diluter valve .....</b>	<b>97</b>
<b>11 Maintenance .....</b>	<b>99</b>
11.1 Exchanging empty bottles .....	99
11.2 Emptying the waste bottle .....	100
11.3 Exchanging hydrophobic air filters .....	100
11.4 Exchanging columns .....	101
11.5 Maintaining the syringe (administrators only) .....	102
11.6 Maintaining the diluter valve (administrators only) .....	103
11.7 Exchanging valves (administrators only) .....	105
11.8 Exchanging the tubing system .....	108
11.9 Preparing for transport .....	109
<b>12 Troubleshooting .....</b>	<b>111</b>
12.1 Access to software help .....	111
12.2 View instrument details .....	111
12.3 Exporting log files .....	111
12.4 Device check .....	112
12.4.1 Waste pump check .....	115
12.4.2 LED check .....	115
12.5 Disruption of processes .....	116
12.5.1 Cell rescue procedure A .....	117
12.5.2 Cell rescue procedure B .....	117
12.6 Issues indicated by an error message .....	118
12.6.1 Hardware error .....	118
12.6.2 Log file analyzer .....	118
12.7 Issues not indicated by an error message .....	119
<b>13 Technical data and specifications .....</b>	<b>121</b>



<b>13.1 FCC compliance statement</b> .....	<b>121</b>
<b>13.2 Technical data</b> .....	<b>122</b>
<b>13.3 EC/EU Declaration of Conformity</b> .....	<b>123</b>
<b>13.4 UK Declaration of Conformity</b> .....	<b>124</b>
<b>14 Technical support</b> .....	<b>125</b>
<b>15 Legal notes</b> .....	<b>127</b>
<b>15.1 Limited warranty</b> .....	<b>127</b>
<b>15.2 Trademarks</b> .....	<b>128</b>



# 1

## Important safety information

### Read the user manual first

#### **WARNING**

Before using the autoMACS NEO Separator, read the chapter **Important safety information** and all other information contained in this user manual, including any safety and operating instructions. Pay special attention to all warnings displayed on the instrument. Failure to read and follow these guidelines could lead to improper or incorrect usage and result in damage to the instrument. Improper usage could also cause severe personal injury, death, unpredictable results, instrument malfunction, and premature wear to components shortening the lifetime of the instrument. Such actions may void your warranty. Keep the user manual and any other safety and operating instructions provided with the instrument in a safe place accessible to all users for future reference.

If you have a serious concern regarding the safe use of your instrument, contact your authorized Miltenyi Biotec service provider or call Miltenyi Biotec Technical Support.

### General safety instructions



THIS CHAPTER DESCRIBES POTENTIALLY HAZARDOUS SITUATIONS ASSOCIATED WITH THIS INSTRUMENT AND PROVIDES IMPORTANT SAFETY INFORMATION TO MINIMIZE THE RISKS AND PROTECT YOURSELF AND OTHERS.

This chapter provides important information for your personal safety and the correct use of the instrument. Read and observe all instructions carefully before proceeding with the installation and use of the instrument. Observe general safety practices in addition to this user manual.

- Use this instrument only as indicated in this user manual to avoid personal injury and property damage.
- Keep this user manual in a place that is always accessible to all users.
- Follow local working area safety instructions and laboratory policies and standards for health, safety, and prevention of accidents.
- In case of severe accidents, damages to the instrument, or if smoke or flames appear, cut the power supply immediately.
- To entirely disconnect the instrument from the power supply, unplug the power cable.
- Ensure that the power switch and the plug of the power cable of the instrument are easily accessible.

### Hazard levels

Signal words are used to warn against hazardous situations and property damages. The following signal words are used in this user manual.

**⚠ WARNING** or **WARNING!** indicates a hazardous situation that, if not avoided, could result in death or serious injury.

**⚠ CAUTION** or **CAUTION!** indicates a hazardous situation that, if not avoided, could result in minor or moderate injury. It is also used to warn against unsafe practices.

**NOTICE** or **NOTICE** indicates information considered important but not hazard related (e.g. messages relating to property damage).

## Symbols



SAFETY WARNING: THE DOCUMENTATION MUST BE CONSULTED IN ALL CASES WHERE THIS SAFETY SYMBOL IS USED ON THE INSTRUMENT



BIOLOGICAL HAZARD



STRONG MAGNETIC FIELD



MOVING PARTS



FOOT CRUSH HAZARD



ERGONOMIC HAZARD



PERSONS WEARING A PACEMAKER OR OTHER ELECTRONIC IMPLANTS MUST MAINTAIN DISTANCE



TWO PEOPLE LIFT REQUIRED



ON (POWER ON)



OFF (POWER OFF)



READ THE USER MANUAL BEFORE USING THE INSTRUMENT



FUSE



WEEE (WASTE OF ELECTRICAL AND ELECTRONIC EQUIPMENT)



ORDER NUMBER

- SN SERIAL NUMBER
- TYP TYPE NUMBER
- MANUFACTURER
- DATE OF MANUFACTURE
- CE EUROPEAN CONFORMITY MARKING
- NRTL CERTIFICATION MARK: PRODUCT MEETS CONSENSUS-BASED STANDARDS OF SAFETY, REQUIRED BY THE OCCUPATIONAL SAFETY/HEALTH ADMINISTRATION (OSHA), DETERMINED BY THE NATIONALLY RECOGNIZED TESTING LABORATORIES (NRTL) TÜV SÜD
- UK  
CA UNITED KINGDOM CONFORMITY ASSESSED MARKING
- FC FCC CERTIFICATION MARKING

### Safety labels

Notice the hazard points and safety symbols of the instrument.

- Keep safety labels and safety markings clean and legible.
- Inspect the safety labels and safety markings regularly and replace them if they are not legible or identifiable from a safe viewing distance.
- Contact Miltenyi Biotec for replacement labels.

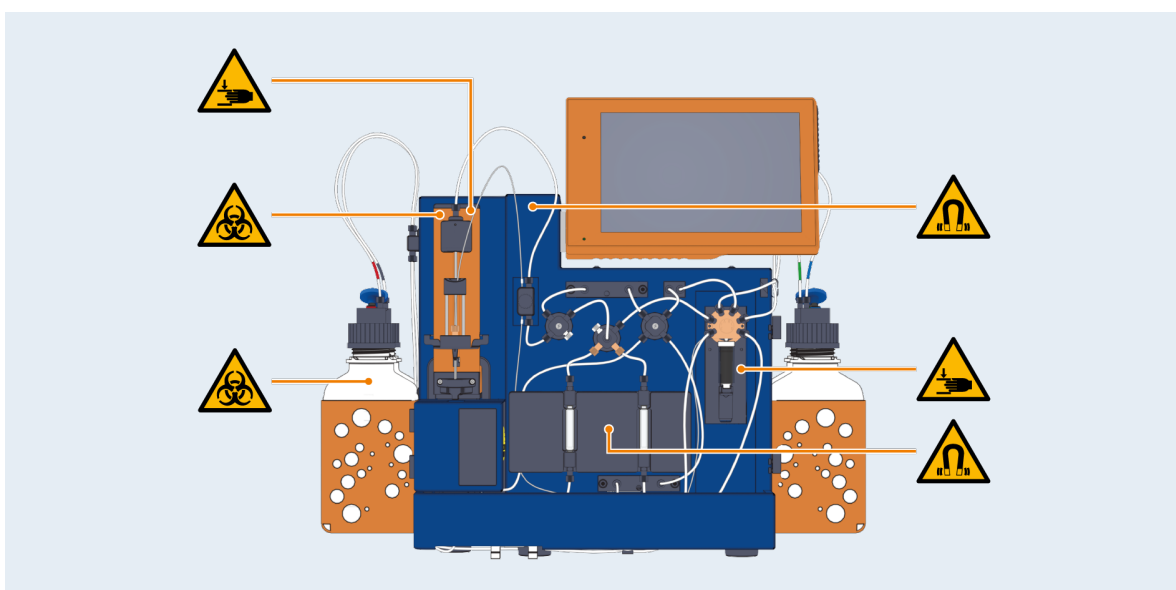

**Figure 1.1:** Hazard areas and safety symbols on the front side of the instrument.

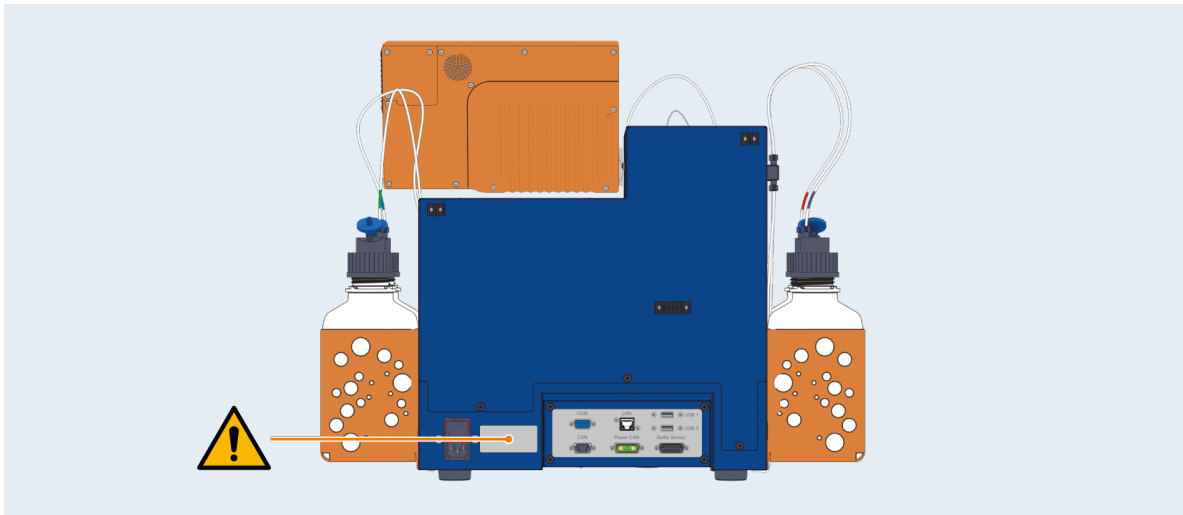

**Figure 1.2:** Hazard areas and safety symbols on the rear side of the instrument.

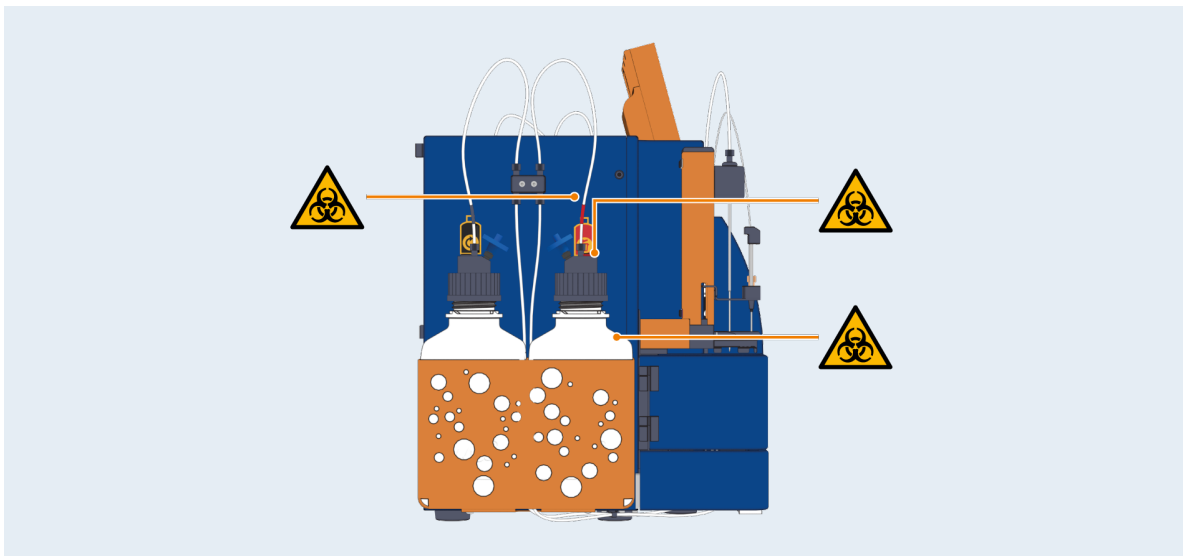

**Figure 1.3:** Hazard areas and safety symbols on the left side of the instrument.

## Electrical and thermal hazards

### **⚠ WARNING**

**Electric devices bear the risk of electric shock, short circuits, overheating, fire, and explosion. This may lead to burns, severe personal injury, or death.**

#### **Protective housing**

The housing of the instrument reduces the risk of an electric shock and short circuits. A short circuit can be caused by disassembled parts or objects that have been dropped into the instrument. Emitted sparks, caused by a short circuit, might ignite combustible vapors or material. The protective housing prevents the spread of fire.

- Do not remove or penetrate any cover of the housing except for the front access covers.
- Only service personnel is allowed to remove any other cover of the instrument.
- Do not use the instrument if it has been dropped or is damaged.
- Do not use the instrument if an object entered the inside of the instrument.

#### **Liquids inside the instrument**

Liquids inside the instrument can cause short circuits.

- Unplug the instrument before cleaning it.
- Use only small amounts of cleaning agents on a soft cloth to wipe the instrument. Do not spray or pour liquid cleaning agents onto or into the instrument.

### Cables and power supplies

Using the instrument with other than the supplied cables is potentially hazardous. The instrument has a three-wire electrical grounding plug with a third pin for grounding. This is a safety feature.

- Do not use the instrument if the power cable is damaged.
- Only use the included power cable.

## Biological hazards

### **WARNING**

**Contamination or infection may lead to severe personal injury or death, depending on the material used.**

### Biological material

All biological material must be considered potentially infectious.

- Do not open the front access covers while the instrument is in operation. Exceptions are maintenance procedures that are explicitly described in this manual.
- Wear personal protective equipment (such as gloves, safety glasses, etc.) as indicated in the safety data sheet for the particular substance.
- Aerosols might leak from the system. Protect mouth and nose if processing hazardous or potentially infectious material that can be transmitted through the air.
- Operate the instrument in a biological safety cabinet suitable for the used specimen if hazardous or potentially infectious materials are processed.
- Decontaminate the instrument after processing hazardous or potentially infectious material.
- If hazardous or potentially infectious material has been spilled or leaked from the system, decontaminate the affected area.
- Run the **Clean** program first before maintenance work on any part of the fluidic system.
- Do not load or unload samples or racks while the instrument is in motion.
- Keep away from the robotic needle arm while the instrument is in operation.
- Leave enough space around the MACS MiniSampler S (at least 15 cm on the left and right side).

### Waste

All liquid and solid waste must be considered hazardous.

- Prefill the empty waste bottle with an appropriate disinfectant according to the specification of the manufacturer.
- Immediately replace the waste bottle after unmounting and fasten the bottle closure to the new bottle.
- Always have an empty waste bottle available.
- To avoid spillages, install only one bottle at a time.
- Autoclave or alternatively decontaminate waste with an appropriate disinfectant.
- Follow the general laboratory safety regulations when handling liquid and solid waste.

### Equipment damage

Defective or inadequate equipment can cause a biological hazard.

- Always inspect the fluidic system and check for leakages before using the instrument.
- Do not use the program **Device check** in case of leakage.
- Exchange hydrophobic air filters once a year to avoid clogging through dust deposits.
- Exchange hydrophobic air filters, if they came into direct contact with any liquid to avoid clogging of the filters and to prevent contamination of liquids.

## Chemical hazards

### **WARNING**

#### **Substances and reagents can be hazardous.**

- All safety measures in section Biological hazards also apply to any hazardous substances and reagents that may be present in the sample.
- Operate the instrument in a fume hood if hazardous substances and reagents are processed.
- Use any substances and reagents only as stated in the respective safety data sheet.
- Only use PBMCs or cells isolated from dissociated tissue, whole blood products, bone marrow, or suspensions containing bacteria or yeast.
- Only use reagents provided by Miltenyi Biotec if not otherwise stated in this manual.

## Magnetic field hazards

### **WARNING**

#### **The instrument has a powerful magnet.**

#### **Magnetizable objects can suddenly move towards the magnet.**

- Keep all magnetic storage devices, electronic equipment, and magnetizable objects at a distance of at least 30 cm from the instrument.

### **WARNING**

#### **The instrument has a powerful magnet.**

#### **Strong magnetic fields can influence the functioning of pacemakers or electronic medical implants.**



If wearing pacemakers or electronic medical implants keep a distance of at least 30 cm from the instrument.

## Mechanical hazards

### **CAUTION**

#### **Moving parts.**

#### **Risk of crushing or cutting.**

### **Fluidic system**

Syringe pumps are parts of the fluidic system. They move while the instrument is in operation.

- Do not open the front access covers while the instrument is in operation. Exceptions are maintenance procedures that are explicitly described in this manual.
- Keep away from the syringe pump while the instrument is in operation.
- Do not obstruct the movement of the syringe pump.



### Robotic needle arm

The robotic needle arm moves while the instrument is in operation.

- Keep away from the robotic needle arm while the instrument is in operation.
- Do not obstruct the movement of the robotic needle arm.

### MACS MiniSampler S

The carriage of the MACS MiniSampler S moves.

- Do not load or unload samples or racks while the instrument is in motion.

#### CAUTION

##### Rotating valve drive.

##### Risk of trapping fingers and hair pulled in.

Valves are part of the fluidic system. The valve drive moves while the instrument is in operation.

- Unplug the instrument before exchanging the valves.
- Do not reach into the valve drive when the valve is disassembled.

#### CAUTION

##### Heavy instrument.

##### Risk of crushing foot.

- Place the instrument only onto stable, even, and vibration free tables or laboratory benches.
  - Only use tables or laboratory benches that support a weight of 160 kg.
- The instrument is heavier at the front.
- Grip the instrument at the base of the orange bottle baskets located at both sides of the instrument.
  - Stabilize the front of the instrument while lifting it.

## Optical radiation hazards

#### CAUTION

##### Powerful LEDs are used to illuminate the bottles.

##### Exposure to optical radiation may cause eye injury.

- Do not remove the bottle holders.

## Ergonomic hazards

#### CAUTION

##### Heavy instrument.

##### Risk of tearing or straining muscles.



Lift the instrument with at least two people.

## Servicing and transportation

### Servicing

Improper servicing or repair of the instrument or use of unauthorized parts can cause malfunction of or damage to the instrument. This can cause hazards to users. Unless otherwise specifically noted in this user manual or other Miltenyi Biotec documentation, do not service the instrument yourself. Servicing and repair must be performed by Miltenyi Biotec certified and qualified service personnel. If the instrument needs servicing, decontaminate the instrument to remove any hazardous material. If you have questions regarding proper decontamination or shipment, contact Miltenyi Biotec Technical Support for assistance. Only use accessories and upgrades recommended by Miltenyi Biotec. Inquire with your local Miltenyi Biotec representative about Miltenyi Biotec's extensive instrument service and service contracts, or refer to [www.miltenyibiotec.com/support](http://www.miltenyibiotec.com/support).

### Transportation

The instrument should be transported with care in packaging specified by Miltenyi Biotec. Internal damage can occur if the instrument is subjected to excessive vibration or if it is dropped. If the instrument needs to be shipped back to the manufacturer for service, contact Miltenyi Biotec for instructions and packaging materials.

### Disposal



#### WASTE OF ELECTRICAL AND ELECTRONIC EQUIPMENT (WEEE) CUSTOMER INFORMATION

Dispose of your end-of-life Miltenyi Biotec products in accordance with the applicable WEEE and hazardous waste disposal legislation, which may differ by country or region. Electrical equipment may contain hazardous substances that may have a serious detrimental effect on the environment and/or human health. All equipment must be specifically collected and treated by designated waste facilities and by qualified WEEE compliance schemas. By ensuring that you dispose of your unwanted electrical and electronic equipment according to the applicable WEEE and hazardous waste disposal legislation, you are helping to preserve our natural resources and protect human health. Miltenyi Biotec is committed to protecting the environment. Miltenyi Biotec offers product end-of-life return programs in many countries, and partners with licensed WEEE compliance schemas throughout the world. Miltenyi Biotec takes back your end-of-life Miltenyi Biotec equipment for recycling free of charge. The terms and availability of this offer vary by geography because of differences in regulatory requirements. Note that, depending on the type and use of your equipment, additional requirements may apply. Before shipping the instrument back to the manufacturer for disposal, decontaminate the instrument to remove any hazardous material. For more information, or if you wish to dispose of your end-of-life Miltenyi Biotec equipment, contact your local Miltenyi Biotec representative or Miltenyi Biotec Technical Support.

# 2

## Introduction

### 2.1 The autoMACS NEO Separator

The autoMACS NEO Separator is a benchtop magnetic cell separator that allows gentle isolation of cells with various separation strategies. Reagent-specific and preset programs simplify and standardize the cell isolation process. The autoMACS NEO Separator features automated sample labeling (autolabeling), sample loading onto the column, elution of the unlabeled negative cell fraction as well as the labeled positive cell fraction. Sensor controlled fluidic level detection and automated buffer dispensing allow for fully automated cell isolation, which is constantly monitored. The touchscreen and software allow for intuitive planning and handling of cell separations. The MACS MiniSampler S holds the MACS Chill Racks and MACS Reagent Racks. Connected to the autoMACS NEO Separator, the MACS MiniSampler S enables correct positioning of samples and reagents so that they can be handled by the robotic needle arm. The MACS Reagent Rack 8 allows for automated labeling with eight reagents. Up to six samples are placed in MACS Chill Racks of different size that keep the samples chilled at +4 to +8 °C.

### 2.2 Intended use

The autoMACS NEO Separator is a laboratory equipment for automated magnetic cell isolation utilizing reusable autoMACS Columns. The instrument can be used either for automated separation of manually labeled cells or for completely automated labeling and separation of cells. In the end the labeled and unlabeled cells are eluted into individual tubes. Isolated PBMCs, dissociated tissue, blood products as well as suspensions containing bacteria or yeast can be applied as starting material. The autoMACS NEO Separator shall only be used with reagents provided or recommended by Miltenyi Biotec. It is to be used only with MACS Chill Racks and MACS Reagent Racks. The autoMACS NEO Separator is for research use only. It is intended to be used in research laboratories and is to be operated by professional laboratory personnel only.

## 2.3 Instrument description

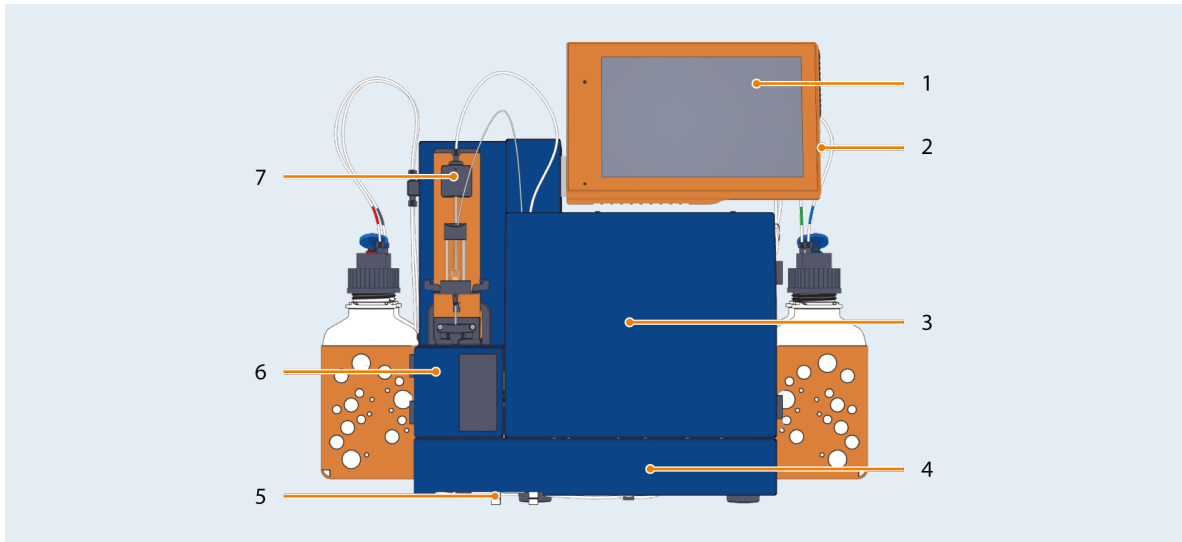

**Figure 2.1:** Front view of the autoMACS NEO Separator with closed covers.

- |   |                |   |                            |
|---|----------------|---|----------------------------|
| 1 | Touchscreen    | 5 | MiniSampler receiving slot |
| 2 | USB ports (x2) | 6 | Washing station cover      |
| 3 | Front cover    | 7 | Robotic needle arm         |
| 4 | Bottom cover   |   |                            |

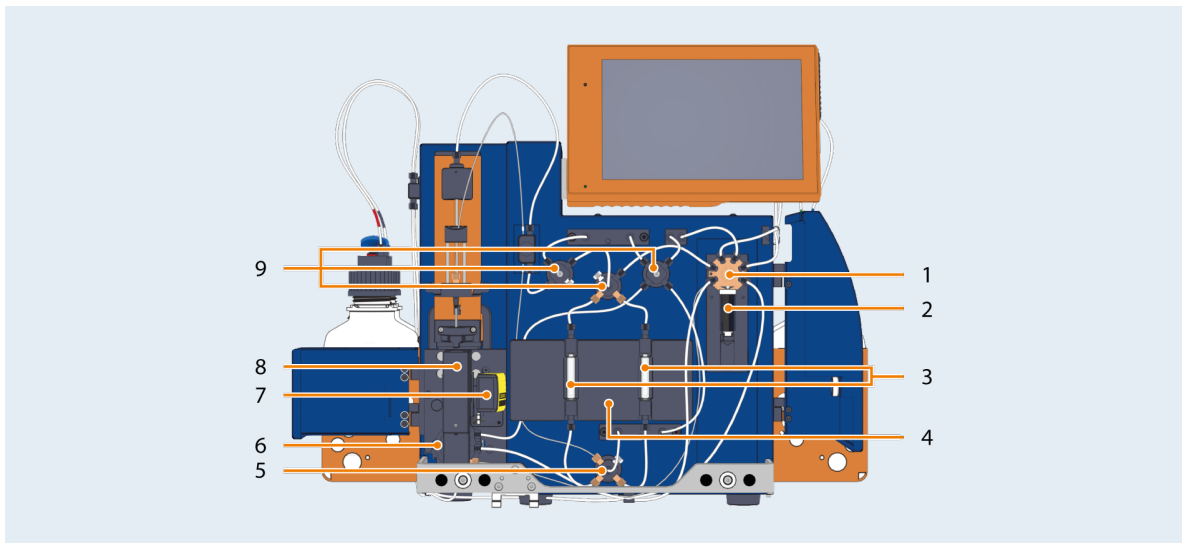

**Figure 2.2:** Front view of the autoMACS NEO Separator with open covers.

- |   |                        |   |                                  |
|---|------------------------|---|----------------------------------|
| 1 | Diluter valve          | 6 | Waste pump                       |
| 2 | Syringe                | 7 | Barcode reader                   |
| 3 | autoMACS Columns       | 8 | Washing station                  |
| 4 | Separation magnet unit | 9 | Top valves (left, middle, right) |
| 5 | Bottom valve           |   |                                  |

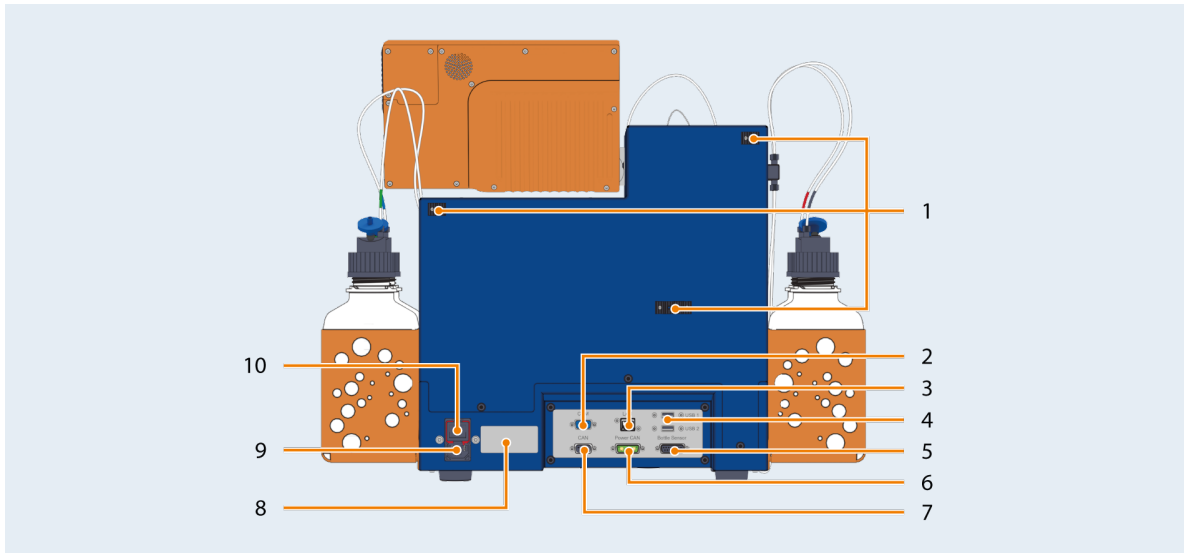

**Figure 2.3:** Rear view of the autoMACS NEO Separator.

- |          |                            |           |              |
|----------|----------------------------|-----------|--------------|
| <b>1</b> | Bottle sensor cable guides | <b>6</b>  | Power CAN    |
| <b>2</b> | COM                        | <b>7</b>  | CAN          |
| <b>3</b> | LAN                        | <b>8</b>  | Type label   |
| <b>4</b> | USB ports (×2)             | <b>9</b>  | Power socket |
| <b>5</b> | Bottle sensor              | <b>10</b> | Power switch |

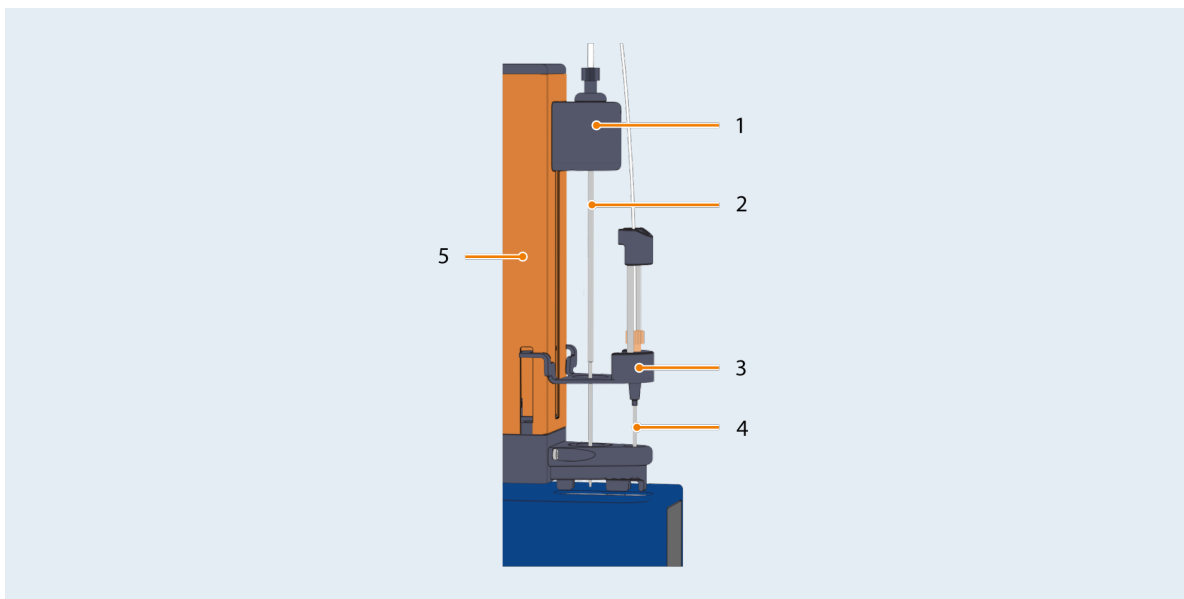

**Figure 2.4:** Needles of the autoMACS NEO Separator.

- |          |   |          |  |
|----------|---|----------|--|
| <b>1</b> | Rear needle holder  | <b>4</b> | Front needle (outlet port negative fraction) |
| <b>2</b> | Rear needle (sample uptake/outlet port positive fraction) | <b>5</b> | Robotic needle arm                           |
| <b>3</b> | Front needle holder                                       |          |  |



# 3

## Installation

Unpacking and installation of the autoMACS NEO Separator should be only done by qualified Miltenyi Biotec representatives.

### **WARNING**

**Electric devices bear the risk of electric shock, short circuits, overheating, fire, and explosion. This may lead to burns, severe personal injury, or death.**

- Do not use the instrument if it has been dropped or is damaged.

### **WARNING**

**The instrument has a powerful magnet.**

**Magnetizable objects can suddenly move towards the magnet.**

- Keep all magnetic storage devices, electronic equipment, and magnetizable objects at a distance of at least 30 cm from the instrument.

### **WARNING**

**The instrument has a powerful magnet.**

**Strong magnetic fields can influence the functioning of pacemakers or electronic medical implants.**



If wearing pacemakers or electronic medical implants keep a distance of at least 30 cm from the instrument.

### 3.1 Components included in the delivery

The following components are included in the delivery of the autoMACS NEO Separator (# 130-120-327):

Component	Position in the transportation box
autoMACS NEO Separator	Lower compartment
MACS Reagent Rack 8	Lower compartment
Chill 5 Rack	Lower compartment
Chill 15 Rack	Lower compartment
Chill 50 Rack	Lower compartment
Rear needle	Lower compartment

Component	Position in the transportation box
autoMACS Columns, 10 pieces	Upper compartment
Power cable	Upper compartment
Fluid bottle sensor cables, 4 pieces	Upper compartment
Hydrophobic air filter, 4 pieces	Upper compartment
Allen wrench	Upper compartment
EC/EU Declaration of Conformity	Upper compartment
UK Declaration of Conformity	Upper compartment
Biohazard warning label, 25 pieces	Upper compartment
autoMACS NEO Separator user manual	Upper compartment
Column substitutes, 2 pieces	Built in
Syringe	Built in
Bottle closure with empty bottles, 4 pieces	Built in
autoMACS Buffer Combination	Separate package
MACS MiniSampler S	Separate order item, separate package

**Table 3.1:** Components included in delivery.

For information about available service contracts for the autoMACS NEO Separator, visit [www.miltenyibiotec.com](http://www.miltenyibiotec.com).

## 3.2 Consumables

Product	Description	Content	Order no.
autoMACS Columns	Separation columns for use with autoMACS instruments	5×2 columns	130-021-101
autoMACS Running Buffer - MACS Separation Buffer	Cell separation buffer, containing sodium azide as preservative	6×1.5 L	130-091-221
autoMACS Rinsing Solution	For preparation of preservative-free cell separation buffer	6×1.45 L	130-091-222
MACS BSA Stock Solution	For preparation of preservative-free cell separation buffer	6×75 mL	130-091-376
autoMACS Washing Solution	For rinsing of the autoMACS NEO Separator's fluidic system	6×1.5 L	130-092-987

**Table 3.2:** autoMACS NEO Separator consumables.



### 3.3 Accessories

Accessory	Description	Order no.
Chill 5 Rack, 1 rack	Chill Rack for 5 mL tubes	130-092-951
Chill 5 Racks, 3 racks	3 Chill Racks for 5 mL tubes	130-097-041
Chill 15 Rack, 1 rack	Chill Rack for 15 mL tubes	130-092-952
Chill 15 Racks, 3 racks	3 Chill Racks for 15 mL tubes	130-097-036
Chill 50 Rack, 1 rack	Chill Rack for 50 mL tubes	130-092-953
Chill 50 Rack, 3 racks	3 Chill Racks for 50 mL tubes	130-097-037
Chill 5, 15, 50 Rack Set	Set of three different MACS Chill Racks	130-097-038
MACS Reagent Rack 8, 1 rack	Accommodates 8 vials of MACS Reagents	130-123-135
Air-Filter Extension Set	Extension tube and hydrophobic air filter for the fluid bottles	130-091-339
autoMACS Pro Laminar Hood Plate	Metal plate for operation in a laminar flow hood	130-093-246
autoMACS Pro Protection Cover	Protection foil for long-term storage	130-093-532

**Table 3.3:** autoMACS NEO Separator accessories.

### 3.4 Unpacking the autoMACS NEO Separator

The packaging of the autoMACS NEO Separator consists of 3 parts (lid, middle part, and bottom). Unpack the instrument as follows:

- 1 Remove the lid to get access to the upper compartment of the packaging.
- 2 Lift out the upper compartment.
- 3 Remove the protective foam grid from the top of the instrument. Grip the foam on the short ribs.
- 4 Pull the middle part of the cardboard packaging upwards to reveal the instrument and the lower compartment.
- 5 Remove the boxes containing the MACS Chill Racks and the MACS Reagent Rack 8.

**CAUTION! Risk of tearing and straining muscles. Lift the instrument with at least two people.**

**CAUTION! Risk of crushing foot. Grip the instrument at the base of the orange bottle baskets located at both sides of the instrument. Stabilize the front of the instrument while lifting it. Place the instrument only onto stable, even, and vibration free tables or laboratory benches. Only use tables or laboratory benches that support a weight of 160 kg.**

- 6 Lift the autoMACS NEO Separator with at least two people out of the packaging by holding it at the base of the orange bottle baskets located at both sides of the instrument. With the other hand reach under the instrument at the front corners to stabilize the front during lifting.
- 7 Place the instrument onto a stable worktop surface and remove the plastic bag surrounding it.
- 8 Remove the foam under the touchscreen by pulling it to the right.
- 9 Carefully remove the foam from the front needle that is installed on the needle arm.
- 10 Remove the foam between waste bottle and needle arm.
- 11 Elevate the touchscreen.

**NOTICE: Ensure adequate air circulation around the instrument. Leave enough space around the instrument (at least 15 cm on the rear side). For instrument dimensions and further technical data, see Table 13.1.**

### 3.5 Installing the needles

The tubings with connectors for the needles are stored under the touchscreen. The front needle is already installed.

- 1 Connect the tubing with small diameter to the front needle. Guide the tubing through the upper holder and screw the tubing connector hand-tight into the needle.

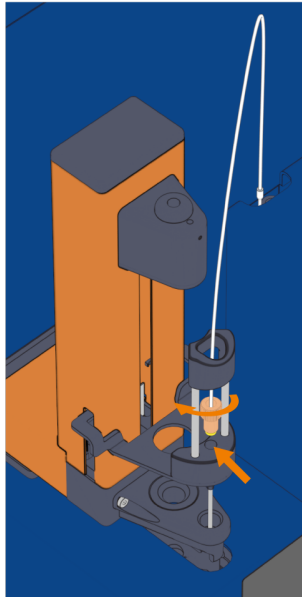

- 2 Remove the rear needle from the packaging and place it into its guiding at the needle arm. The inner part of the holder is flexible and held inside by a magnet. You can pull it out to insert the needle if needed.

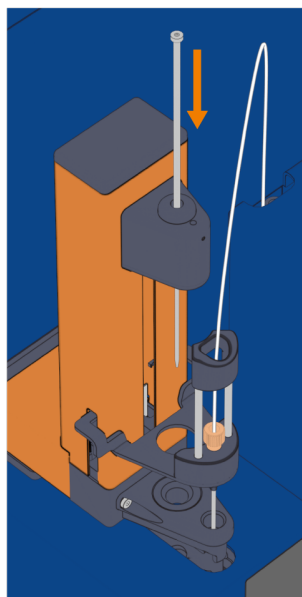

- 3 Connect the tubing with larger diameter to the rear needle. Screw the tubing connector hand-tight into the needle holder.

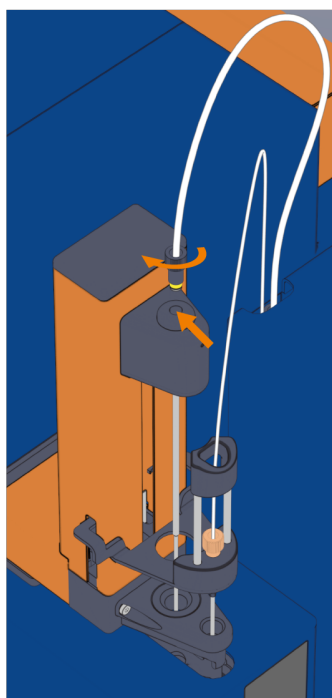

- 4 Open the front cover and the washing station cover and retighten all tubing connectors at the valves, the diluter valve and the washing station.
- 5 Close all covers.

### 3.6 Preparing liquids

For proper operation of the autoMACS NEO Separator, fluid bottles must be filled with a minimum volume of 200 mL. The liquids in **Table 3.4** are required for daily operation.

Solution		Description
autoMACS Running Buffer – MACS Separation Buffer	Delivered, ready-to-use, sterile filtered	Contains sodium azide as a preservative. To prepare an azide-free running buffer, dilute the MACS BSA Stock Solution 1:20 with autoMACS Rinsing Solution ( <b>Table 3.2</b> ).
autoMACS Washing Solution	Delivered, ready-to-use, sterile filtered	For rinse of the fluidic system after any cell separation. It contains detergents and stabilizer and has been developed for optimal cleaning of the autoMACS NEO Separator tubing system ( <b>Table 3.2</b> ).
Storage solution	Self-preparation	Consists of 70% (v/v) analytical-grade ethanol. Prepare with double-distilled water. Do not use denatured ethanol (technical ethanol), as the autoMACS Columns are not resistant to oxidative compounds.
Bleach solution	Optional, self-preparation	Consists of 1% sodium hypochlorite (v/v).

**Table 3.4:** Liquids required for operation of the autoMACS NEO Separator.

Use sterile liquids to prevent contamination of the fluidics system. Only use the listed liquids. A reproducible and optimal performance of the instrument cannot be guaranteed when the instrument is operated with other liquids.

### 3.7 Installing the fluid bottles

#### **⚠ WARNING**

##### **Biohazardous waste.**

**Contamination or infection may lead to severe personal injury or death, depending on the material used.**

- Prefill the empty waste bottle with an appropriate disinfectant according to the specification of the manufacturer.





#### **⚠ CAUTION**

**Powerful LEDs are used to illuminate the bottles.**

**Exposure to optical radiation may cause eye injury.**

- Do not remove the bottle holders.

The autoMACS NEO Separator is delivered with four empty fluid bottles that are connected to the instrument with specifically designed bottle closures. The bottle closures consist of a fluid uptake port or in case of the waste bottle, a fluid outlet port. The bottle closures have a sensor for measuring electrolyte conductivity to measure the filling status. A connected hydrophobic air filter keeps the liquids sterile. The fluid bottles, bottle closures, and fluid sensor cables are color-coded (**Table 3.5**).

Color	Placement	Bottle	Symbol
Blue	Front right	autoMACS Running Buffer – MACS Separation Buffer	
Green	Rear right	autoMACS Washing Solution	
Black	Rear left	Storage solution	
Red	Front left	Waste	

**Table 3.5:** Color-coding and placement of the fluid bottles.

To avoid contamination and spillover, do not open a full bottle before it is placed in its holder. Change one fluid bottle at a time.

Install the fluid bottles as follows:

- 1 Prefill an empty waste bottle with an appropriate disinfectant.
- 2 Place full fluid bottles and the waste bottle into the appropriate holders.
- 3 Replace the screw caps by the delivered bottle closures and fasten them securely (**Figure 3.1**).
- 4 Attach the sensor cable plug to the socket labeled **Bottle Sensor** at the rear side of the autoMACS NEO Separator (**Figure 2.3**) and fasten securely.
- 5 Align the red marks on the sensor cable connectors in the bottle closures and the sensor cables.

**NOTICE: Do not screw in the sensor cable.**

- 6 Plug each sensor cable into the respective connector of the bottle closure. The sensor cable and the corresponding connector in the bottle closure have the same color-coding (**Table 3.5**).
- 7 Attach the sensor cables to the cable guides at the rear side of the autoMACS NEO Separator (**Figure 2.3**).
- 8 Connect the color-coded tubings to the respective fluid uptake port or fluid outlet port of the bottle closures.
- 9 Connect the hydrophobic air filters (0.2  $\mu\text{m}$ ) to the appropriate connectors on the bottle closures to keep liquids sterile. Avoid any contact of the hydrophobic air filter with liquids as this may cause clogging of the filter.

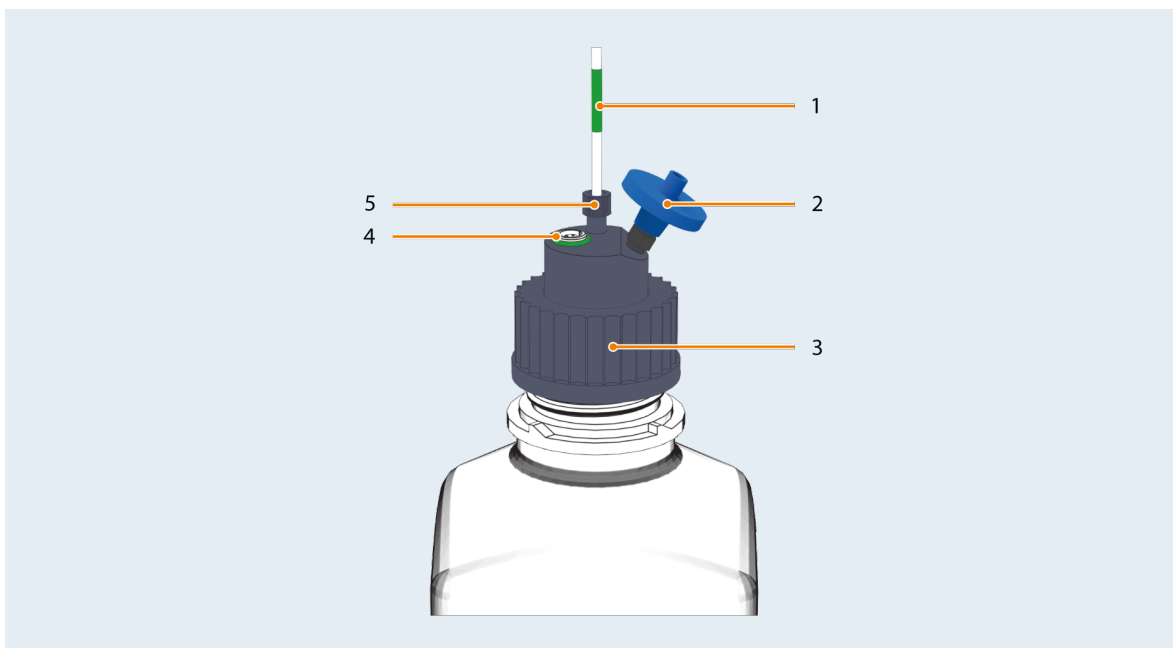

**Figure 3.1:** Bottle closure.

- |   |                        |   |                             |
|---|------------------------|---|-----------------------------|
| 1 | Color-coded tubing     | 4 | Connector for bottle sensor |
| 2 | Hydrophobic air filter | 5 | Fluid uptake/outlet port    |
| 3 | Bottle closure         |   |                             |

### 3.8 Installing the MACS MiniSampler S

Connect the MACS MiniSampler S to the instrument. Follow the instructions in the MACS MiniSampler S user manual.

**⚠ WARNING**

**Electric devices bear the risk of electric shock, short circuits, overheating, fire, and explosion. This may lead to burns, severe personal injury, or death.**

- Do not use the instrument if the power cable is damaged.
- Only use the included power cable.

- 1** Make sure that the power switch is in position **O** (off) before connecting the power cable. The power switch is located on the rear side of the instrument (**Figure 2.3**).
- 2** Connect the power cable to the power socket at the rear side of the instrument (**Figure 2.3**).
- 3** Plug in the power cable to a grounded power outlet.

# 4

## Setting up the instrument

### 4.1 Switching on

- 1 Switch on the instrument with the power switch on the rear side of the instrument (**Figure 2.3**). If the LED of the touchscreen lights up white, the instrument is in standby mode.
- 2 Tap the touchscreen to power up the autoMACS NEO Software. Wait until the software is loaded completely.
- 3 After initialization **Home** is displayed by default.

If the LED of the touchscreen lights up green and dims on and off, an automatic **Wake up** is scheduled.

### 4.2 Switching off

Switch off the instrument with the power switch on the rear side of the instrument (**Figure 2.3**). Switch off the instrument before long term storage. For some maintenance procedures switch off is also required. Make sure that the fluidic system is filled with storage solution when switching off.

For overnight storage switch the instrument into standby mode, see chapter **Switching into standby below**.

Automatic processes from the task planner, for example the automatic **Wake up**, cannot be started if the instrument is switched off. Make sure that the instrument is switched on to use these functions.

### 4.3 Switching into standby

The standby mode is recommended for overnight storage and allows a quick restart of the autoMACS NEO Separator user interface. Standby includes a **Sleep** program, see chapter **Sleep on page 90**.

- 1 Tap the **Shutdown** button in the title bar. A message box opens.
- 2 Tap **Standby**. A white LED on the touchscreen indicates that the instrument is in standby mode.
- 3 Tap the touchscreen to resume.

### 4.4 Shutting down

For some maintenance processes shutdown is required. Shut down the instrument also for long term storage. Run the **Store** program before shutting down the instrument for long term storage, see chapter **Store on page 91**.

- 1 Tap the **Shutdown** button in the title bar. A message box opens.
- 2 Tap **Shutdown**.
- 3 Wait until the software is shutted down, which is indicated by a white LED on the touchscreen.
- 4 Switch off with the power switch on the rear side of the instrument (**Figure 2.3**).

## 4.5 Login

The **Login** box is located in the upper left corner of the **Home** tab. It is only displayed if no user is logged in.

- 1 Enter the username and password into the **Login** box.

The screenshot shows a 'Login' dialog box with a title bar. Below the title bar, there are two input fields: 'Username' containing the text 'user' and 'Password' containing a series of dots. To the right of the password field is an orange button labeled 'Login'.

- 2 Tap **Login**.



- 3 The **Login** box disappears and the user name is shown on the left side of the title bar next to the **User** symbol.

## 4.6 First login

During the first instrument setup, Miltenyi Biotec service personnel will set up an administrator account for you. See chapter **Setting up user accounts on page 82** for instructions on how to create additional administrator and user accounts.

## 4.7 Logout



- 1 Tap the **User** symbol in the title bar to open the **User** menu.



- 2 Tap the **Logout** symbol.

For shutdown of the instrument, logout is not required.

## 4.8 Calibration

### CAUTION

**Moving robotic needle arm.**

**Risk of crushing or cutting.**

- Do not obstruct the movement of the robotic needle arm.
- Keep away from the robotic needle arm while the instrument is in operation.

The autoMACS NEO Separator is calibrated with two programs, **Rack calibration** and **Volume calibration**. Adjust date and time before the first calibration to save the correct calibration date, see chapter **Setting date and time on page 46**.

The calibration result and the calibration values are displayed in a message box after the calibration.



### 4.8.1 Rack calibration

**Rack calibration** automatically calibrates the rack position on the MACS MiniSampler S.

Run the rack calibration after:

- instrument or software installation
- moving the instrument, for example during maintenance
- dismounting and reinstallation of the MACS MiniSampler S
- exchange of the MACS MiniSampler S
- exchange of one or both needles.

A Chill 15 Rack is needed for the rack calibration. For instructions on how to place racks on the MACS MiniSampler S, see MACS MiniSampler S user manual.

- 1 Go to **Tools > Calibration**.
- 2 Select **Rack calibration**.
- 3 Place an empty Chill 15 Rack onto the MACS MiniSampler S.
- 4 Follow the instructions on the display.
- 5 Tap **Start**.

Make sure that no object is obstructing the needle arm during calibration. Use an empty Chill 15 Rack for rack calibration. No tubes shall be placed.

### 4.8.2 Volume calibration

**Volume calibration** automatically calibrates the liquid volume control. This is crucial for correct measurement and processing of the sample volumes.

Run the volume calibration after:

- instrument or software installation
- exchanging the syringe
- exchanging any of the valves
- exchanging the tubing or tubing parts

- 1 Ensure that all bottles are filled with the appropriate solutions and that the waste bottle is empty.
- 2 Go to **Tools > Programs**.
- 3 Select **Rinse**.
- 4 Tap the **Start** button and wait until the program **Rinse** has been finished. The fluidic system is filled with autoMACS Running Buffer – MACS Separation Buffer.
- 5 Go to **Tools > Calibration**.
- 6 Select **Volume Calibration**.
- 7 Follow the instructions on the display.
- 8 Tap **Start**.

## 4.9 Priming the instrument

### **WARNING**

**Defective or inadequate equipment can cause a biological hazard.**

**Contamination or infection may lead to severe personal injury or death, depending on the material used.**

- Always inspect the fluidic system and check for leakages before using the instrument.

Priming includes the initial cleaning and filling of the autoMACS NEO Separator fluidic system with autoMACS Running Buffer – MACS Separation Buffer to prepare the instrument for separation. The instrument must be primed first to reach the instrument status **Ready**. Before the first priming after installation, ensure that the rack calibration has been done, see chapter **Rack calibration on the previous page**.

The priming process takes approximately 4 minutes. In order to save time you can schedule a **Wake up** in the morning. This program includes a **Prime**.

- 1 Ensure that all bottles are filled with the appropriate solutions. Empty the waste bottle.
- 2 Ensure that the MACS MiniSampler S is installed correctly, see MACS MiniSampler S user manual for details.
- 3 Tap the **Prime** button in the toolbar. Alternatively, go to **Tools > Programs**, select **Prime** and tap the **Run** button.
- 4 When priming has been finished, the instrument will display **Ready** in the **Overview** pane of the **Home** tab and the bottle illumination will change from blue to green.
- 5 After priming the instrument, open the front cover and check the fluidic system for potential leaks.

## 4.10 Installing autoMACS Columns

### **WARNING**

**The instrument has a powerful magnet.**

**Magnetizable objects can suddenly move towards the magnet.**

- Keep all magnetic storage devices, electronic equipment, and magnetizable objects at a distance of at least 30 cm from the instrument.

### **WARNING**

**The instrument has a powerful magnet.**

**Strong magnetic fields can influence the functioning of pacemakers or electronic medical implants.**



If wearing pacemakers or electronic medical implants keep a distance of at least 30 cm from the instrument.

When delivered, the column slots contain column substitutes. Before operation at least the left column substitute must be replaced by an autoMACS Column. Depending on the separation program one or two columns are required for separation. Contact Miltenyi Biotec Technical Support if you have questions regarding the separation programs.

Adjust date and time before installing columns the first time to save the correct installation date, see chapter **Setting date and time on page 46** for details.

Store the column substitutes. They can be reinstalled if the instrument is not used for more than 14 days, see chapter **Store** on page 91.

- 1 Ensure that the fluid bottles are filled with the appropriate solutions.
- 2 Switch on the instrument and log in.
- 3 Run the **Prime** program, see chapter **Priming the instrument on the previous page**.
- 4 Remove all racks from the MACS MiniSampler S.
- 5 Open the front cover of the autoMACS NEO Separator.
- 6 Go to the **Home** tab. The **Columns** pane shows that two column substitutes are installed.

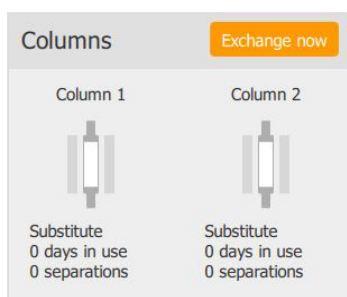

- 7 Tap the **Exchange now** button to start column exchange. Alternatively, go to **Tools > Column exchange**. The **Column exchange** program opens.

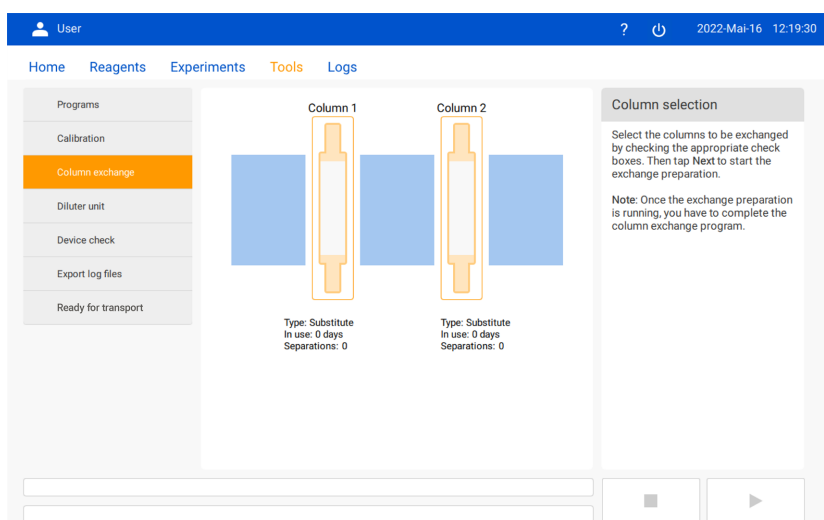

- 8 Select one or both columns to be exchanged.
- 9 Tap **Next**. The instrument prepares the columns for exchange. Wait until the preparation is complete.
- 10 Tap **Next**. Select **Regular** as new column type(s) to be installed in place of the column substitutes.
- 11 Tap **Next** to continue. Read the instructions on the screen on how to replace the columns.
- 12 Using both hands, take the top and the bottom of the column substitute and pull gently to remove it from its slot in the magnet.
- 13 Hold the column substitute in one hand and unscrew the bottom column connector clockwise and the top column connector counter-clockwise (**Figure 4.1**).
- 14 Insert a random end of a regular autoMACS Column into the bottom column connector and screw in the column by turning it clockwise until you feel resistance.
- 15 Point the column towards the top of the instrument and screw in the top connector.
- 16 Align the column with the top connector sitting on the guiding of the magnet cover.
- 17 Press the column into the slot until you feel the guides click.
- 18 Verify that the column is placed in the center of the magnet cover.

- 19 Optional: Repeat steps 12 to 18 with the right column substitute.
- 20 Ensure that the tubing is neither pinched nor obstructed.
- 21 Tap **Next** to finish the column exchange. The instrument will run a **Prime** to fill the new columns with buffer and the instrument status will change to **Ready**.
- 22 Check that the columns are securely fastened to the column connectors and that no buffer is leaking.
- 23 Close the front cover.

The autoMACS Columns can be used for a maximum of 14 days or 100 separations. The instrument automatically records the date of the column exchange and shows how many days the columns have been installed for. The instrument also displays the type of columns that are currently installed and the number of separations performed with each column.

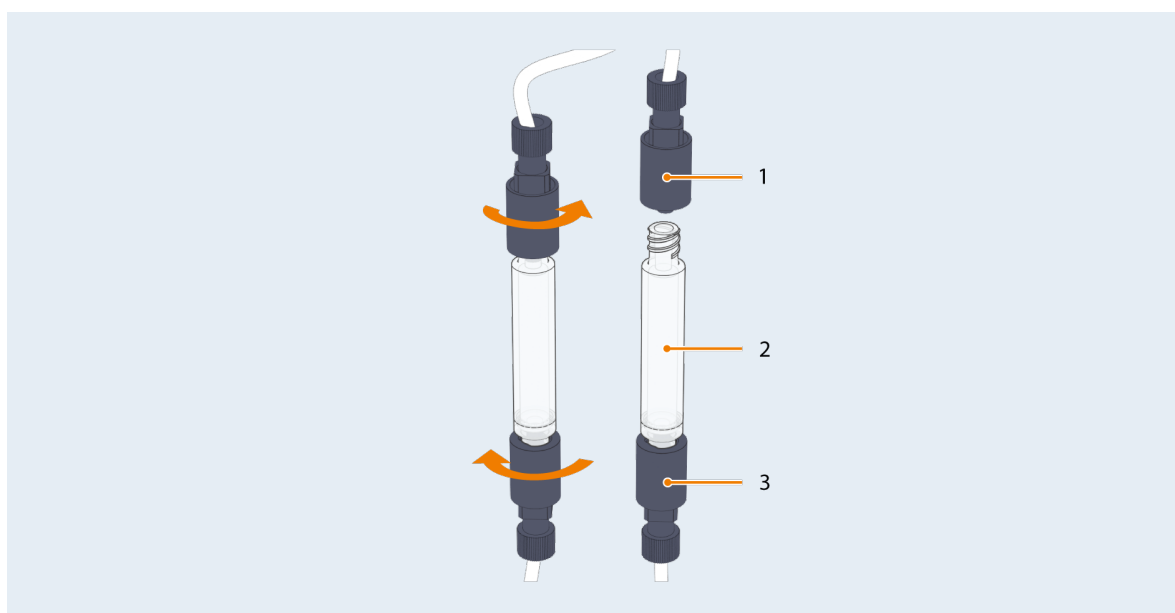

**Figure 4.1:** Removal of autoMACS Columns

- |   |   |
|---|---|
| <ol style="list-style-type: none"> <li>1 Top column connector</li> <li>2 autoMACS Column</li> </ol> | <ol style="list-style-type: none"> <li>3 Bottom column connector</li> </ol> |
|---|---|

## 4.11 Testing the barcode reader

- 1 Go to the **Home** tab.
- 2 Tap the **Scan reagent** button in the toolbar.
- 3 Hold a barcode, e.g. the test barcode below, in front of the barcode reader. If the scan was successful, a dialog box requests placement of the reagent on the reagent rack.



**Figure 4.2:** Test barcode (CD4 MicroBeads, human, # 130-045-101).

## 4.12 The Task planner

Use the **Task planner** to organize reservations for experiments and to schedule an automatic **Wake up** and **Sleep** program. An automatic **Wake up** includes a **Prime** program.

The **Task planner** is located in the center of the **Home** tab.

For the **Sleep** program a task is scheduled for 6:00 p.m. as default. The administrator can change the scheduling for the **Sleep** task.

### 4.12.1 Viewing tasks

- 1 Go to the **Task planner**. All scheduled tasks for the selected date are shown.

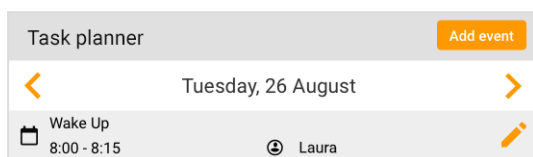

- 2 Use the arrow buttons to view tasks of previous or following dates.

### 4.12.2 Creating tasks

- 1 Go to the **Task planner**.
- 2 Tap **Add event**.

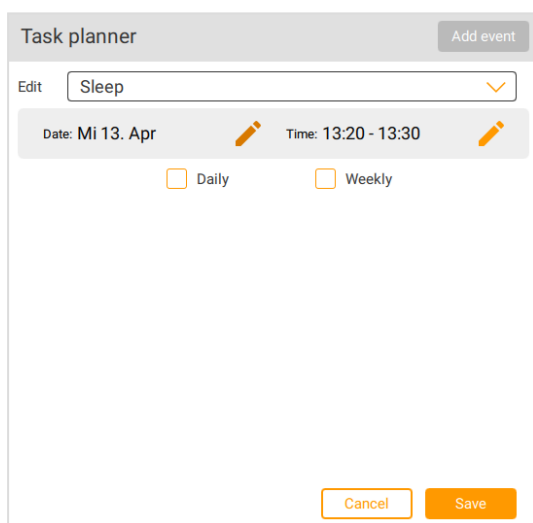

- 3 Select **Sleep**, **Wake up**, or **Reservation**.
- 4 Enter date and time.
- 5 Check the boxes **Daily** or **Weekly** to repeat the task every day or week.
- 6 Tap **Save**.
- 7 Check the liquid levels when scheduling an automatic **Wake up** or **Sleep** program.

If a **Wake up** is scheduled, the LED on the touchscreen lights up green and dims on and off, see chapter **Touchscreen LED on page 75**.

When scheduling a **Wake up**, make sure that the instrument is shut down or in standby mode.

If processes or separations are still running at the scheduled sleep time, the **Sleep** program will not start.



# 5

## The user interface

### 5.1 Structure

The autoMACS NEO Software user interface includes the following elements (see also **Figure 5.1**):

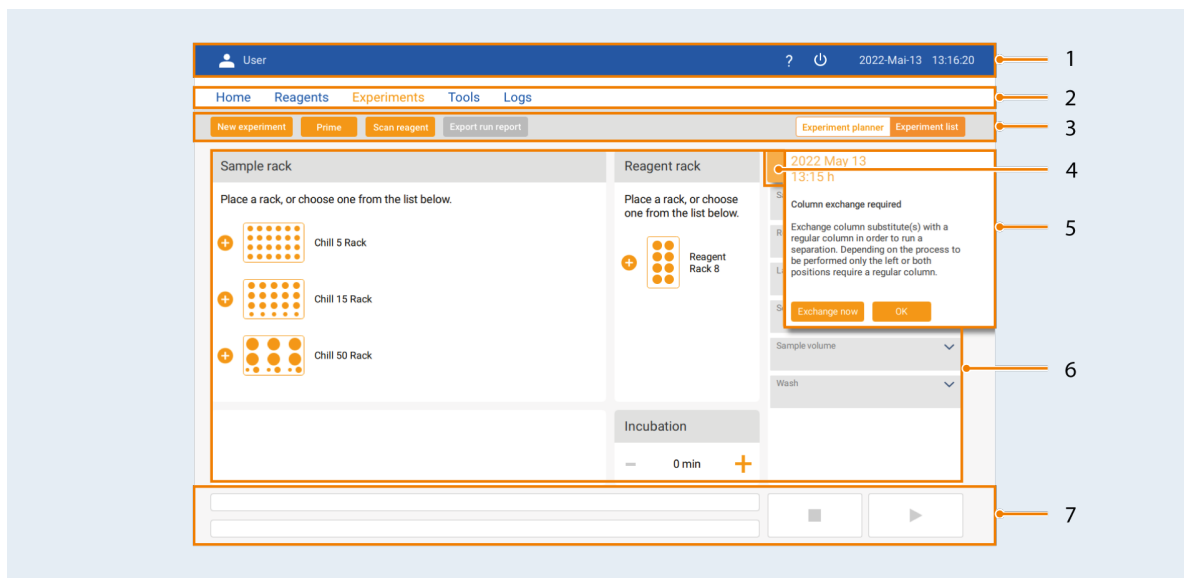

**Figure 5.1:** autoMACS NEO Software user interface.

- |   |                       |   |                      |
|---|-----------------------|---|----------------------|
| 1 | Title bar             | 5 | Message box          |
| 2 | Menu bar              | 6 | Currently opened tab |
| 3 | Toolbar               | 7 | Progress bar         |
| 4 | Flag (of message box) |   |                      |

## 5.1.1 Title bar

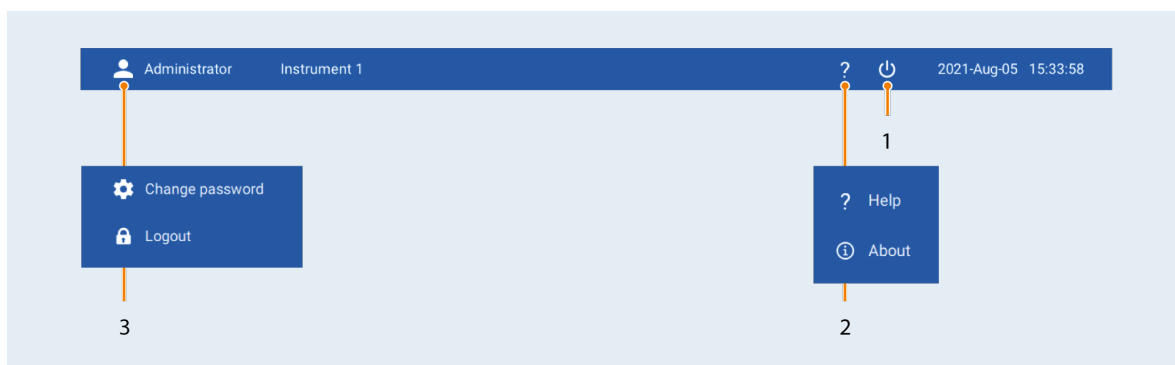



**Figure 5.2:** The title bar.

- |   |                           |
|---|---------------------------|
| <p><b>1</b> Shutdown button</p> <p><b>2</b> Help menu</p> | <p><b>3</b> User menu</p> |
|---|---------------------------|

The title bar (**Figure 5.2**) shows:

- the logged in user
- the instrument name
- date and time

Additionally the following buttons are available in the title bar:

	<b>User</b>	Opens the <b>User</b> menu with functions to change password or log out.
	<b>Help</b>	Opens the <b>Help</b> menu with functions to open the autoMACS NEO Software help or the <b>About</b> box with system information.
	<b>Shutdown</b>	Opens a message box with buttons to shut down the instrument or turn the instrument into standby mode.

**Table 5.1:** Buttons of the title bar.

## 5.1.2 Menu bar



**Figure 5.3:** The menu bar

The menu bar (**Figure 5.3**) provides access to the tabs listed in **Table 5.2**. The selected tab is highlighted. For further information on the respective functions, see chapter **The user on page 41** and **The administrator on page 44**.



Tab	Function
<b>Home</b>	After starting the instrument, the <b>Home</b> tab is displayed by default. It shows the current status of the instrument including liquid levels, column status and scheduled tasks, and enables actions such as column exchange or scheduling a new task.
<b>Reagents</b>	Shows a list that contains all reagents and kits that are available for autolabeling. Allows filtering by different parameters and searching for keywords.
<b>Experiments</b>	Setup and start of a cell separation process and overview of all experiments with filter option.
<b>Tools</b>	Access to additional programs, such as calibration, washing programs, and maintenance.
<b>Settings</b>	Only available for administrators. Access to general instrument settings, such as date and time and user management. Access to file export and software update.
<b>Logs</b>	Filter the log file, e.g., to look up previous error messages or device check results.







**Table 5.2:** Tabs of the autoMACS NEO Separator user interface.

### 5.1.3 Toolbar and currently opened tab



**Figure 5.4:** The toolbar (**Load recent log messages** button not shown).

The toolbar (**Figure 5.4**) is visible in the **Home** tab, **Reagents** tab, **Experiments** tab, and **Logs** tab. The toolbar has the following buttons for quick access to specific functionalities according to the selected tab, **Experiment planner**, and **Experiment list**:

	<b>New experiment</b>	Opens the <b>Experiment planner</b> .
	<b>Prime</b>	Starts the <b>Prime</b> program.
	<b>Scan reagent</b>	Activates the barcode reader.
	<b>Export run report</b>	Starts the export of the run report to an attached USB flash drive. The button is only visible in the <b>Experiments</b> tab.
	<b>Experiment planner</b>	Switches to the <b>Experiment planner</b> . The button is only visible in the <b>Experiments</b> tab.
	<b>Experiment list</b>	Switches to the <b>Experiment list</b> . The button is only visible in the <b>Experiments</b> tab.
	<b>Load recent log messages</b>	Refreshes the log messages list. The button is only visible in the <b>Logs</b> tab.

**Table 5.3:** Buttons of the toolbar.

The options of the selected tab are displayed in the middle of the screen.

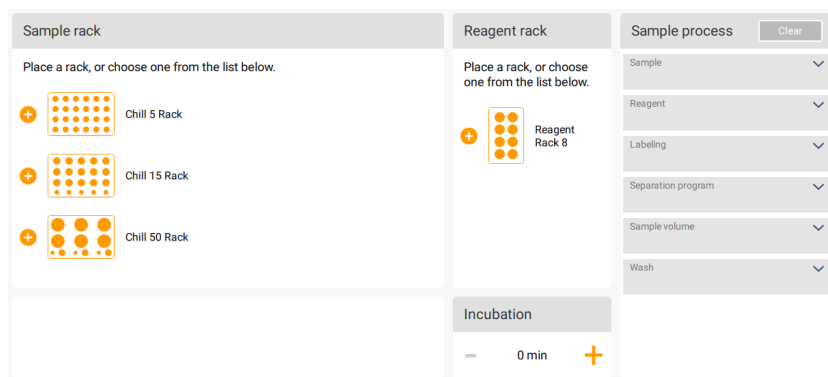

**Figure 5.5:** Currently opened tab pane (here: **Experiments** tab).

### 5.1.4 Message box

The message box is displayed at the right side of the screen if a status message or an error occurs. The color of the message box indicates the severity level of the issue.

For further information, see chapter **Messages on page 77**.

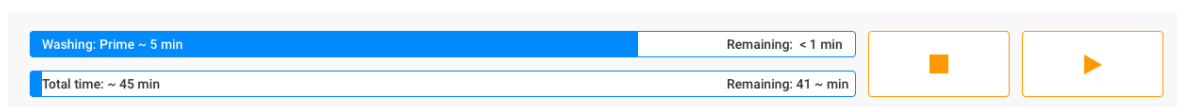

### 5.1.5 Progress bar

The progress bar (**Figure 5.6**) shows the progress of an experiment or program and the elapsed time in two separate bars. The upper bar shows the name and elapsed time of the current step. The lower bar shows the name and elapsed time of the whole experiment or process.



**Figure 5.6:** The progress bar.

Two buttons are located to the right side of the progress bar. These buttons are to be used to start or stop experiments and programs (**Table 5.4**). They may be inactive (grayed out) during certain processes/in some menus.

	<b>Run</b>	Starts an experiment. If a finished experiment can be restarted with the same parameters, the button turns to <b>Rerun</b> .
	<b>Stop</b>	Stops the current experiment.
	<b>Rerun</b>	Displayed instead of the <b>Run</b> button when an experiment is finished. Creates a copy of the finished experiment with identical parameters, but a new experiment name and creation date. Then it is possible to start the experiment again.

**Table 5.4:** Buttons of the progress bar.

## 5.2 The user

### 5.2.1 Home tab

The **Home** tab (**Figure 5.7**) has different panes that display the current status of the instrument and consumables for the daily work.

Pane	Function
<b>Login</b>	The <b>Login</b> box disappears after successful login.
<b>Overview</b>	Shows the current instrument status.
<b>Task planner</b>	Shows planned tasks, e.g. experiments, and enables to save new tasks.
<b>Columns</b>	Provides information about the currently installed columns and enables column exchange.
<b>Liquid</b>	Shows the current filling level of all fluid bottles.

**Table 5.5:** Elements of the **Home** tab.

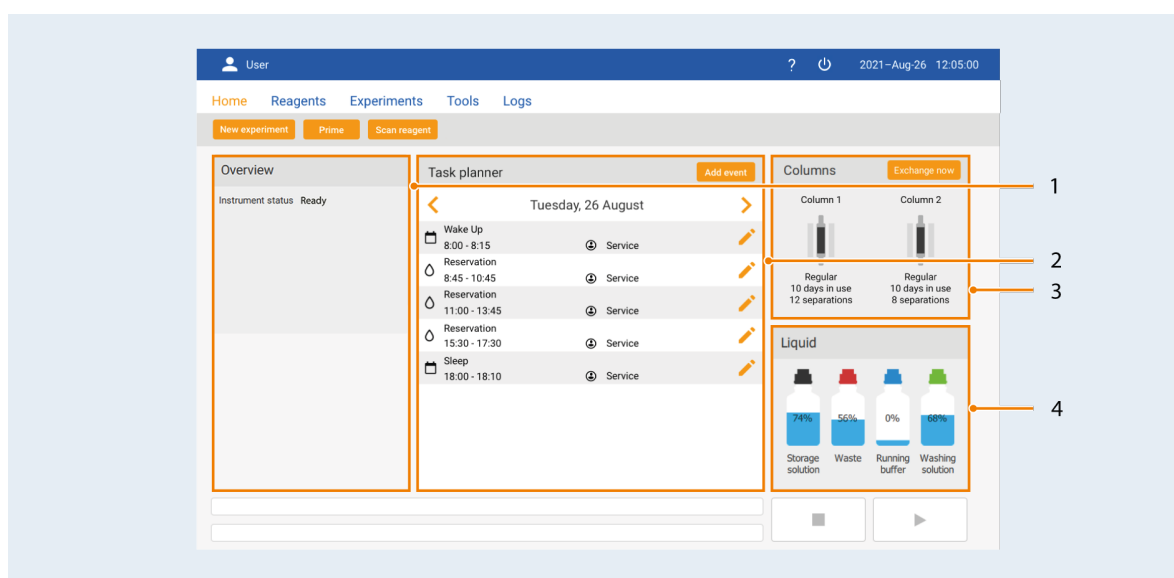
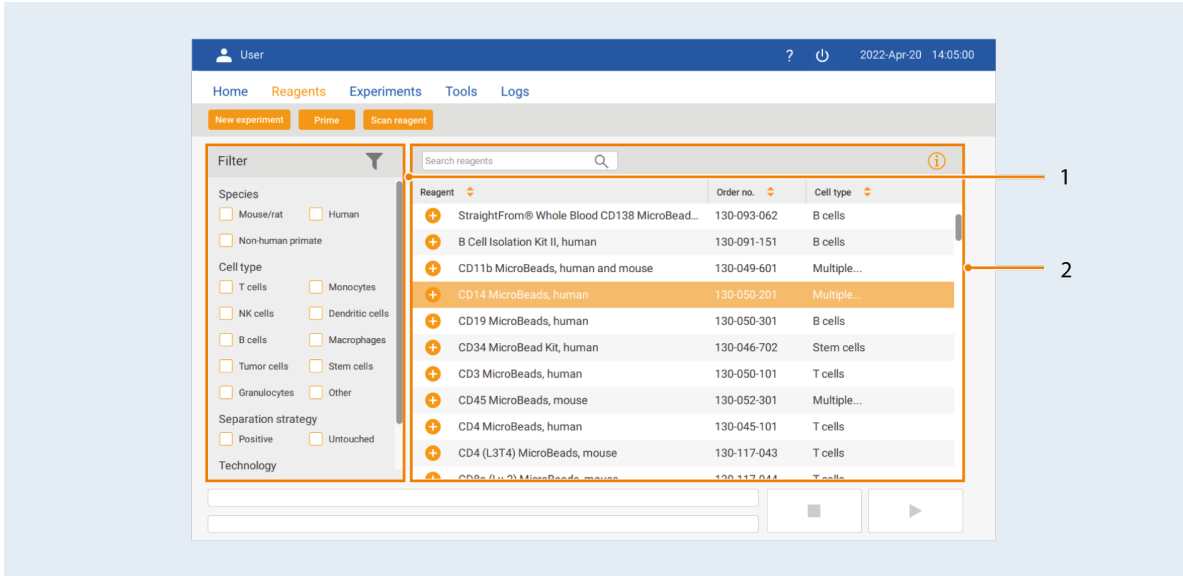

**Figure 5.7:** The **Home** tab.

- |   |               |   |              |
|---|---------------|---|--------------|
| 1 | Overview pane | 3 | Columns pane |
| 2 | Task planner  | 4 | Liquid pane  |

### 5.2.2 Reagents tab

The **Reagents** tab (**Figure 5.8**) shows a list of all reagents that are currently available for labeling. The number of reagents shown can be limited either by a filter function on the left hand side of the screen or by using the search bar. For more information on how to use the reagent list, see chapter **Using the Reagents tab on page 68**.



**Figure 5.8:** The Reagents tab.

- 1 Reagent filter
- 2 Reagent list with search box

**5.2.3 Experiments tab**

The **Experiments** tab consists of the **Experiment planner** to set up new experiments (**Figure 5.9**) and the **Experiment list** that shows a list of all experiments. Tap the respective buttons in the toolbar to switch between the views.

After selection of the **Experiments** tab the **Experiment planner** is shown by default. For use of the **Experiment list**, see chapter **Using the Experiment list on page 67**.

The **Experiment planner** has the following five panes:

Pane	Function
<b>Sample rack</b>	Represents the sample rack that is placed onto the MACS MiniSampler S.
<b>Reagent rack</b>	Represents the reagent rack that is placed onto the MACS MiniSampler S.
<b>Sample process/Reagent details</b>	Displays information related to the selected position(s).
<b>Summary table</b>	Is visible after a sample rack is selected and shows an overview of the planned experiment.
<b>Incubation</b>	Setting an incubation time.

**Table 5.6:** Functions of the **Experiment planner** in the **Experiments** tab.

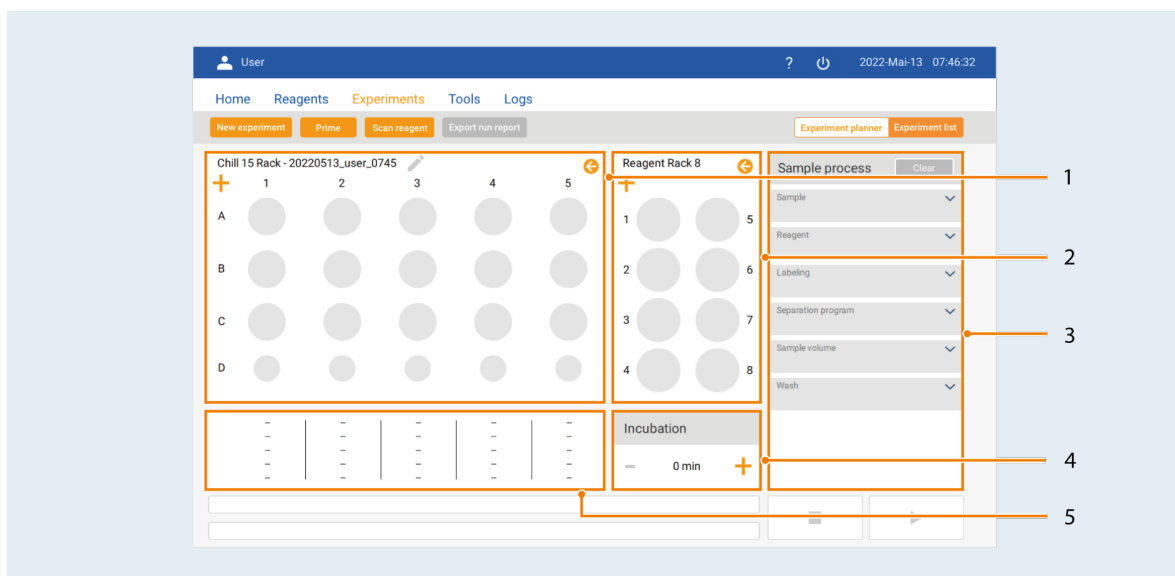

**Figure 5.9:** The Experiment planner.

- |   |   |   |                 |
|---|---|---|-----------------|
| 1 | Selected sample rack                      | 4 | Incubation time |
| 2 | Selected reagent rack                     | 5 | Summary table   |
| 3 | Sample process definition/Reagent details |   |                 |

## 5.2.4 Tools tab

The **Tools** tab (**Figure 5.10**) provides access to the following programs:

Tools list pane		Provides access to program(s)
<b>Programs</b>	Washing: Maintenance: Other:	QRinse, Rinse, Clean Prime, Sleep, Store, Bleach Rescue
<b>Calibration</b>		Rack calibration Volume calibration
<b>Column exchange</b>		Column exchange
<b>Valve exchange</b> (for administrators)		Valve exchange
<b>Diluter Unit</b> (for administrators, except diluter valve cleaning)		Clean diluter valve Exchange syringe Exchange valve Exchange syringe and valve
<b>Device check</b>		Device check
<b>Export log files</b>		Export log files
<b>Ready for transport</b>		Ready for transport

**Table 5.7:** Programs provided by the **Tools** tab (**Figure 5.10**).

In the middle pane of the screen the desired program or instrument part, e.g. column to exchange, can be selected. The pane on the right-hand side of the screen provides instructions for the selected program.

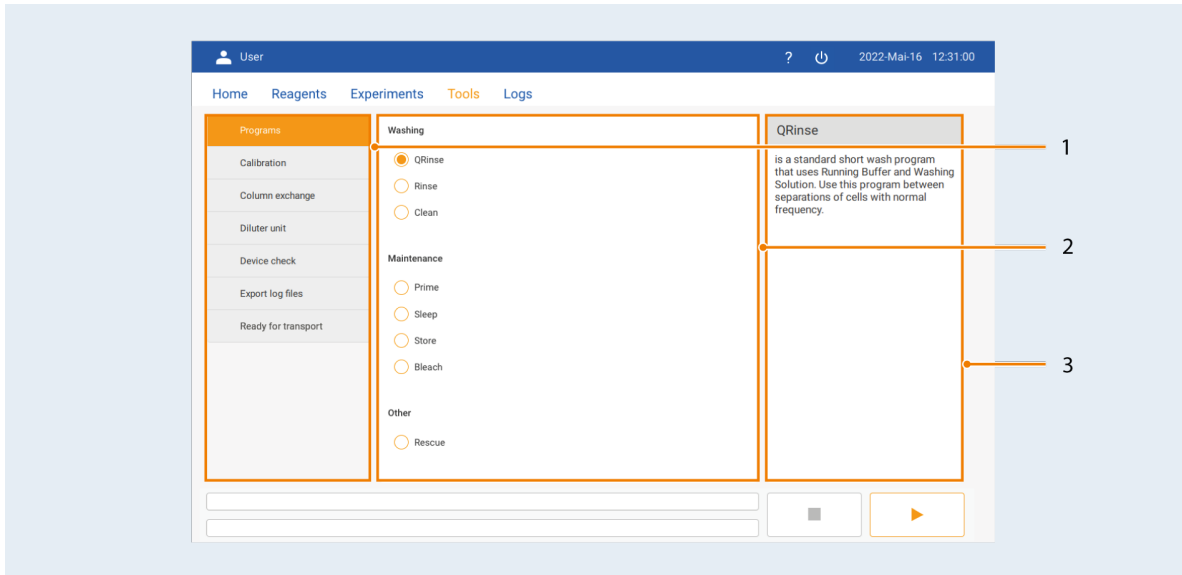
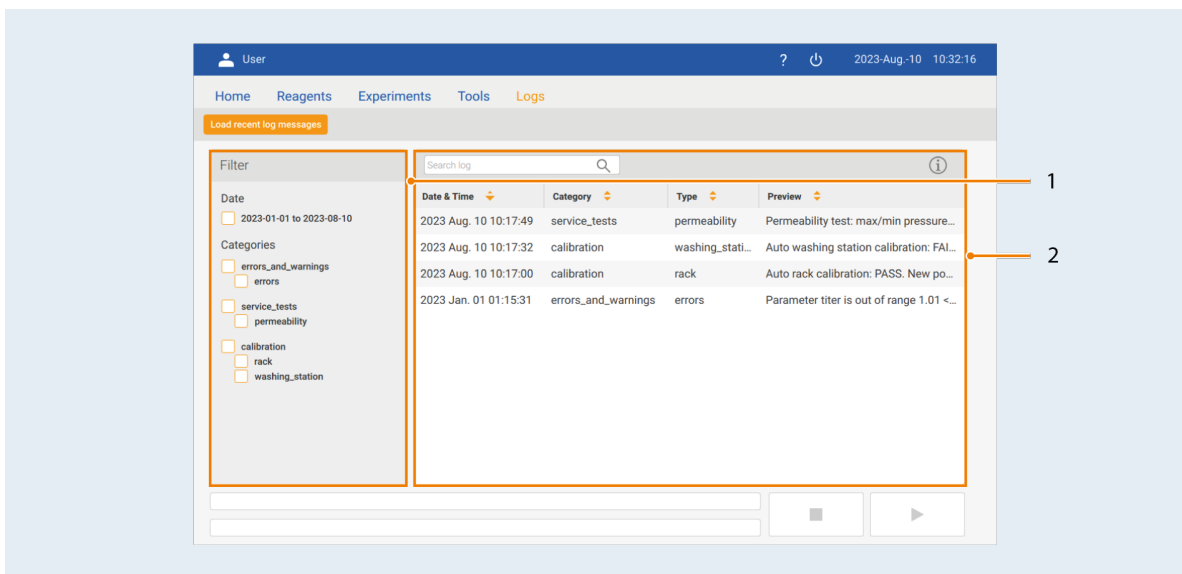

**Figure 5.10:** The **Tools** tab.

- |   |                              |   |              |
|---|------------------------------|---|--------------|
| 1 | Tools list                   | 3 | Instructions |
| 2 | Program selection or details |   |              |

## 5.2.5 Logs tab

The **Logs** tab contains a log file analyzer to look up previous warnings, error messages, and device check results. For details see **Log file analyzer on page 118**.



**Figure 5.11:** The **Logs** tab.

- |   |                |   |                              |
|---|----------------|---|------------------------------|
| 1 | Message filter | 2 | Message list with search box |
|---|----------------|---|------------------------------|

## 5.3 The administrator

In addition to all tabs accessible to users, administrators have access to the **Settings** tab.

### 5.3.1 Settings tab

The **Settings** tab provides information about the instrument and allows adjustment of general settings. The following functions are available:

- **General settings** including access to the **Service UI** for file export and software updates
- **User management**
- **Date and time**
- **Experiment settings**

For a detailed description of the **User management**, see chapter **User management on page 81**.

### 5.3.2 Assigning an instrument name

- 1 Go to **Settings > General settings**.
- 2 Enter the name into the field **Instrument name**. The instrument name is shown in the title bar next to the user name.

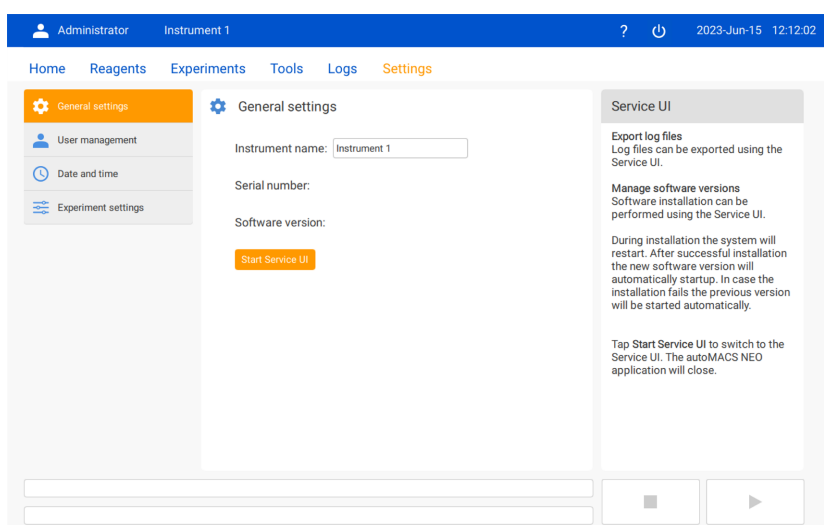

### 5.3.3 Installing new software version

- 1 Go to **Settings > General settings**.

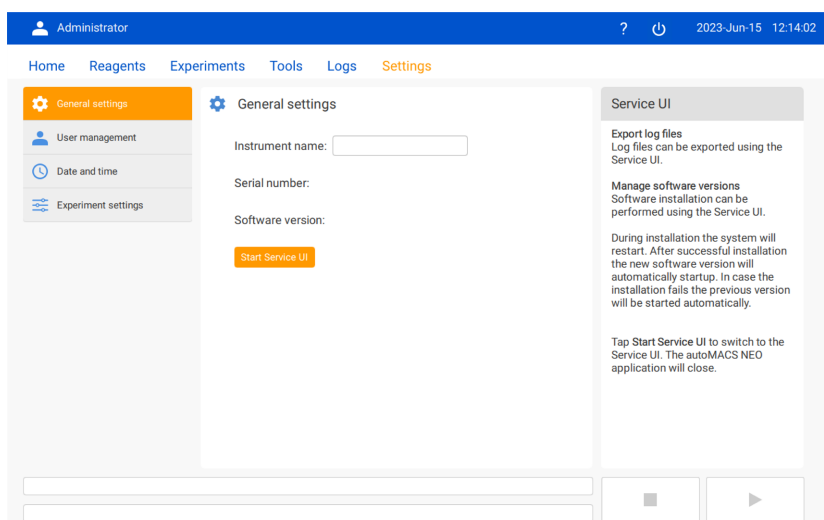

- 2 Tap **Start Service UI** to switch to the **Service UI**. A message box appears. Confirm to close the autoMACS NEO software. The **Service UI** opens.
- 3 The touchscreen has two USB ports on the right-hand side. Insert an USB flash drive into one of the ports.
- 4 Go to **Updates > Install a new image**.

- 5 Select a file from the USB flash drive and tap **OK** to start the update.
- 6 If the update was successful, **Image has been successfully installed** is shown.
- 7 Go to **USB storage > Unmount USB storage** before disconnecting the USB flash drive. Tap **OK**.
- 8 To restart the autoMACS NEO software, tap the button **Close Service-UI**. Tap **OK** to confirm.

In case of problems after the update, you can return to the previous software version, see chapter **Returning to previous software version below**.

### 5.3.4 Returning to previous software version

In case of problems after a software update, you can return to the previous software version.

- 1 Go to **Settings > General settings**.
- 2 Open the **Service UI**.
- 3 Go to **Updates > Rollback to another slot** and tap **OK**.

### 5.3.5 Setting date and time

Make sure that date and time are always correct to save the right column installation and calibration date.

After changing the date and time, the instrument needs to be restarted.

- 1 Go to **Settings > Date and time**.

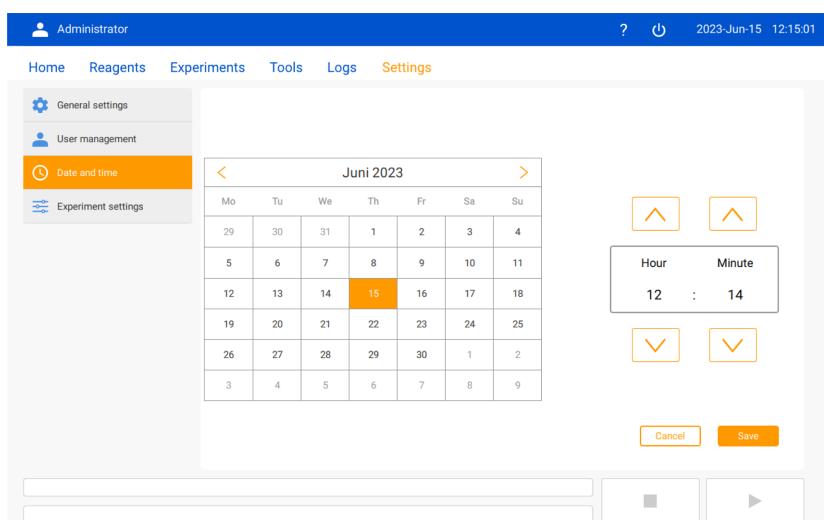

- 2 Select the date and adjust the time with the arrow buttons.
- 3 Tap **Save**. A message box appears.
- 4 Tap **Save and restart** in the message box to save the changes. The instrument will shut down and restart.

### 5.3.6 Shortening the experiment time for autolabeling

This function specifies whether the instrument should adhere exactly to the incubation time when processing autolabeling samples or if the incubation time may be exceeded by up to 100%.

Adhering to the exact incubation time leads to longer experiment duration. If exceeding of the incubation time is allowed, the instrument interleaves sample processing and thus the experiment time is shortened.

Shortening of the experiment time is activated by default.



To change the settings, do the following:

**1 Go to Settings > Experiment settings.**

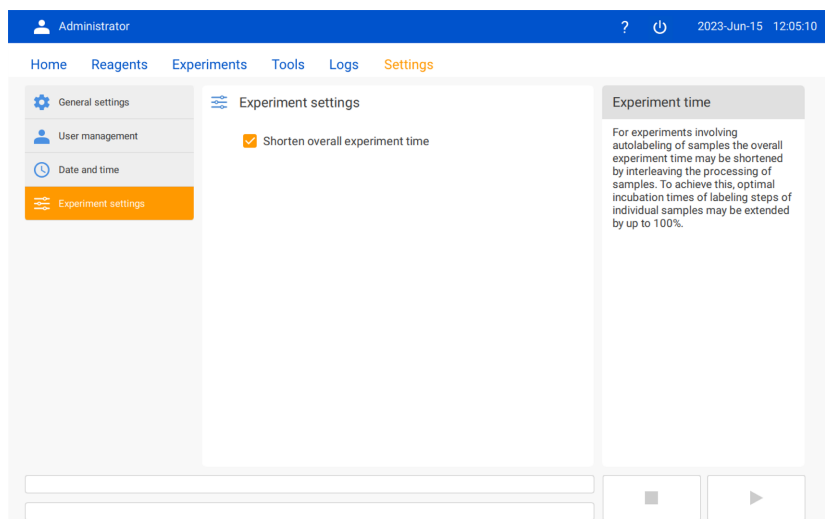

**2 Clear the box Shorten overall experiment time.**

All autolabeling samples will be incubated for the designated incubation time.



# 6

## Setting up an experiment

### **WARNING**

**Defective or inadequate equipment can cause a biological hazard.**

**Contamination or infection may lead to severe personal injury or death, depending on the material used.**

- Always inspect the fluidic system and check for leakages before using the instrument.

### **WARNING**

**Biohazardous material.**

**Contamination or infection may lead to severe personal injury or death, depending on the material used.**

- Wear personal protective equipment (such as gloves, safety glasses, etc.) as indicated in the safety data sheet for the particular substance.
- Operate the instrument in a biological safety cabinet suitable for the used specimen if hazardous or potentially infectious materials are processed.
- Do not load or unload samples or racks while the instrument is in motion.
- Keep away from the robotic needle arm while the instrument is in operation.

This chapter describes all steps to start an experiment immediately after definition.

The main steps are:

- 1 Starting setting up an experiment - see chapter **Beginning on the next page**.
- 2 Defining the separation process - see chapter **Defining the separation process on the next page**.
- 3 Placing the tubes - see chapter **Placing the tubes on page 55**.
- 4 Function options for setting up an experiment - see chapter **Function options for setting up an experiment on page 56**.
- 5 Running an experiment - see chapter **Running an experiment on page 67**.

Alternatively you can start your experiment later. All experiments are automatically saved in the **Experiment list**. For instructions on how to start prior defined experiments from the **Experiment list**, see chapter **Using the Experiment list on page 67**.

In addition, this chapter provides information on how to use four important functions:

- Stopping an experiment - see chapter **Stopping an experiment on page 67**.
- Using the **Experiment list** - see chapter **Using the Experiment list on page 67**.
- Using the **Reagents** tab - see chapter **Using the Reagents tab on page 68**.
- Exporting a report of an experiment - see chapter **Exporting a run report on page 68**.

## 6.1 Beginning

1 Go to the **Experiments** tab. The **Experiment planner** opens.

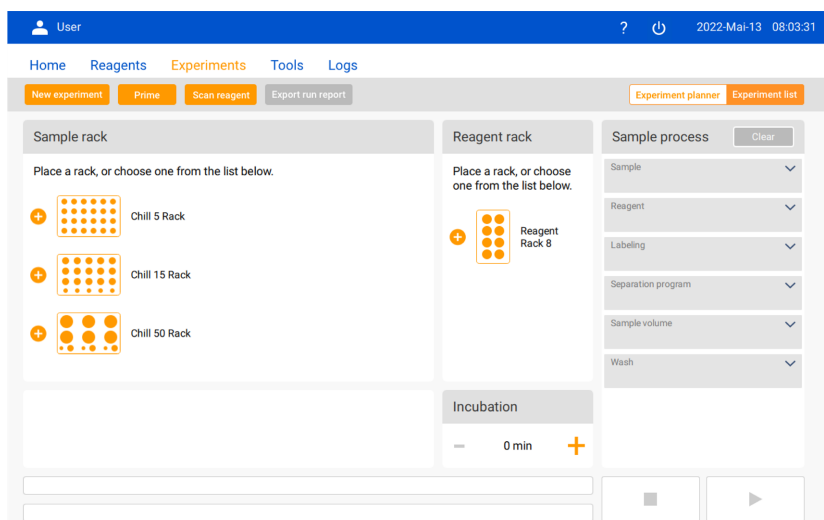

2 For further proceeding, see chapter **Defining the separation process below**.

## 6.2 Defining the separation process

The steps required for definition of the separation process differ, depending on the labeling method. There are two options to label the cell samples: autolabeling and manual labeling.

- Autolabeling:

For autolabeling, see chapter **Autolabeling below**.

- Manual labeling:

If working with manual labeling, follow the labeling instructions in the data sheet of the cell separation reagent and see chapter **Manual labeling on page 53**.

### 6.2.1 Autolabeling

It is recommended to store the MACS Chill Racks in the refrigerator at +2 to +8 °C until the coolant switched into solid state. Depending on the refrigerator and rack type, it takes at least 3 hours until the coolant switches into solid state. Do not cool below 0 °C, as samples may freeze.

- 1 Place the Chill Rack on the MACS MiniSampler S.
- 2 Select the same Chill Rack in the **Experiments** tab. An experiment is created automatically. The default experiment name is shown next to the rack name.
- 3 Place the MACS Reagent Rack 8 on the MACS MiniSampler S.
- 4 Select the same MACS Reagent Rack 8 in the in the **Experiments** tab.

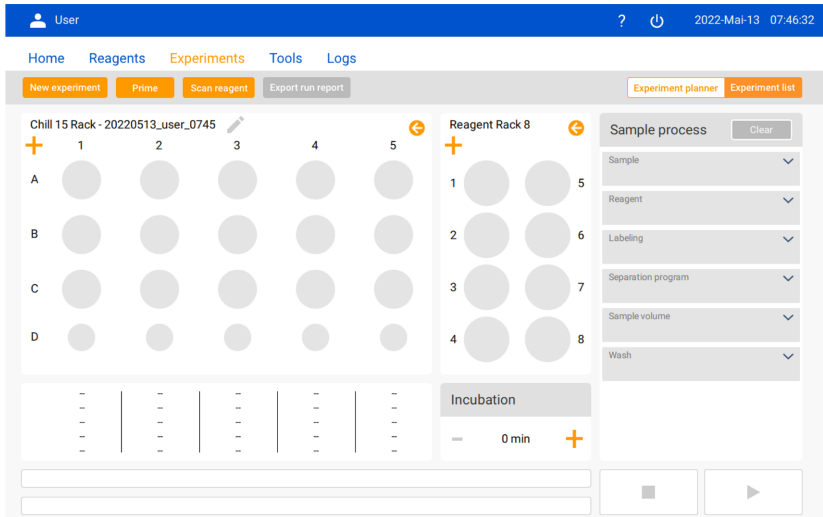

- 5 Tap the position on the sample rack you want to assign a reagent to. An orange outline around the position indicates that it is selected.

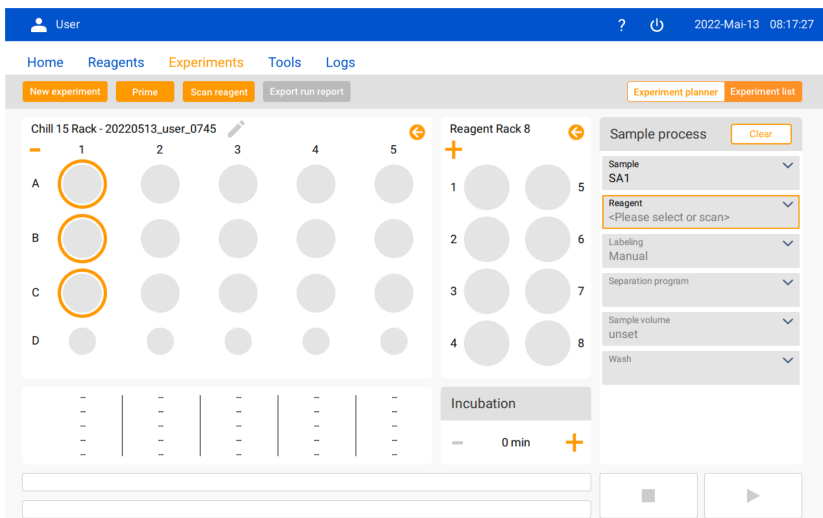

- 6 Optional: Enter a custom sample name, see chapter **Assigning custom sample names on page 66**.
- 7 If the reagent has no barcode, tap **Reagent** in the **Sample process** pane. The 15 most recently selected reagents are displayed. Select a reagent or tap **More reagents...** to go to the **Reagents** tab, see chapter **Using the Reagents tab on page 68**.
- 8 If the reagent has a barcode, scan the code as described in chapter **Scanning reagents on page 61**.
- 9 A dialog box specifies the position of the reagent on the reagent rack. The reagent is placed on the first free position on the reagent rack. Tap **Place reagent(s) on Reagent Rack**.

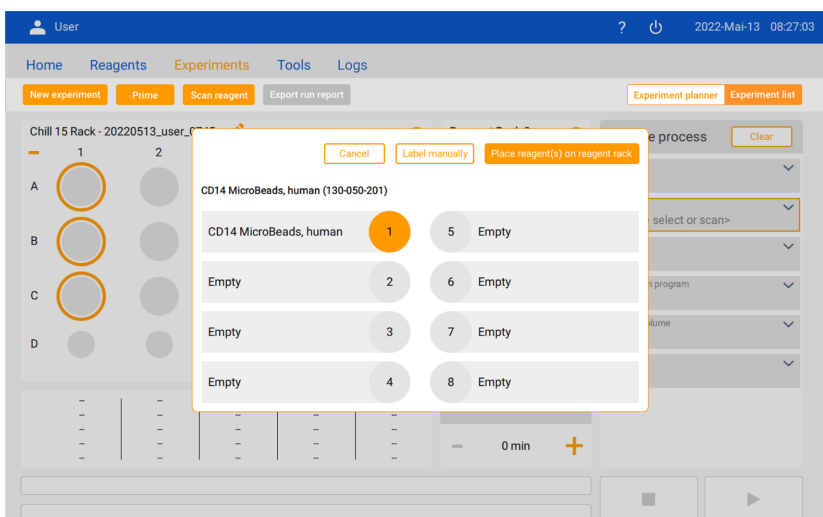



- The reagent name is now visible on the selected position and is assigned to your sample, which is indicated by the link symbol next to the reagent.

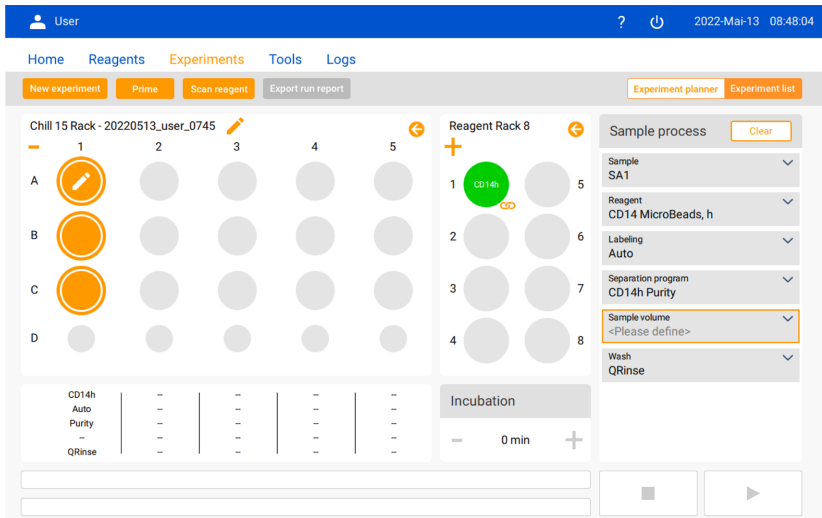

- If desired, tap **Separation program** in the **Sample process** pane to change the preset separation program. See chapter **autoMACS NEO separation programs** on page 73 for details.
- Tap **Sample volume**. The range of possible sample volumes is shown.

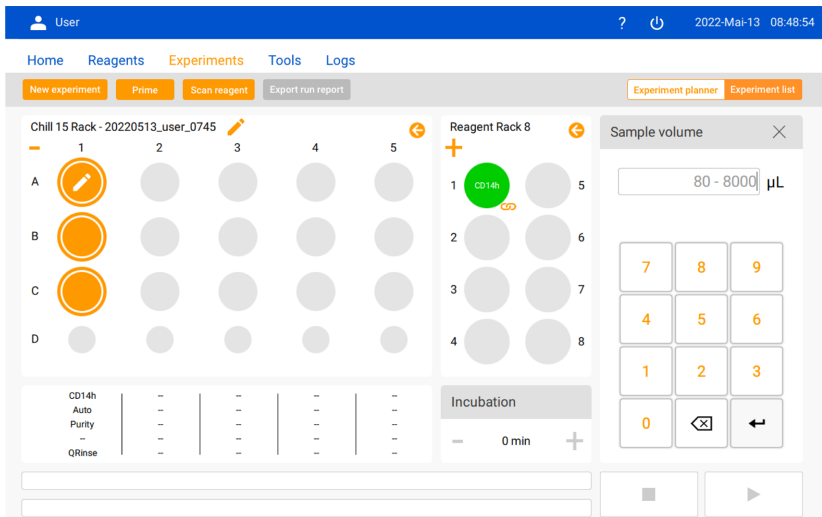

- Enter the sample volume and tap the return key. The sample position color changes to green and the **Ready for processing** symbol is shown in sample position A1 (Table 8.3).

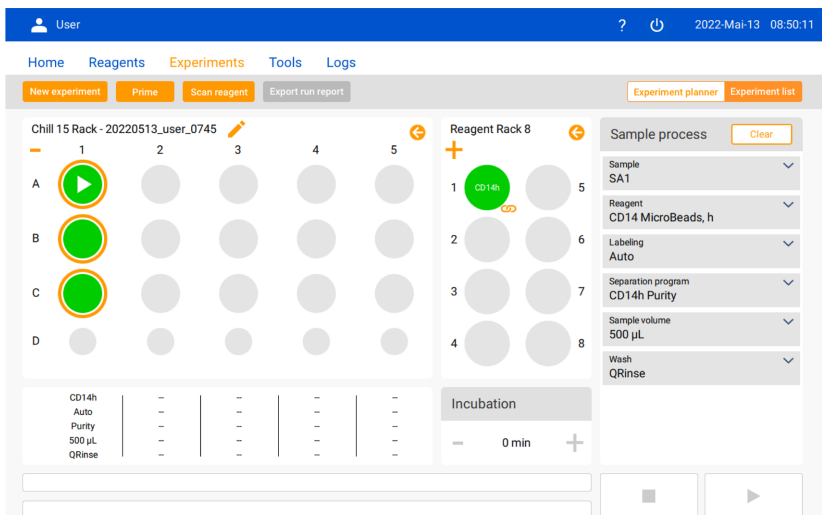

- 14 If desired, change the preset wash program. Tap **Wash** and select a wash program to be run after the separation. For more information on the available wash programs, see chapter **Washing and maintenance programs on page 89**.

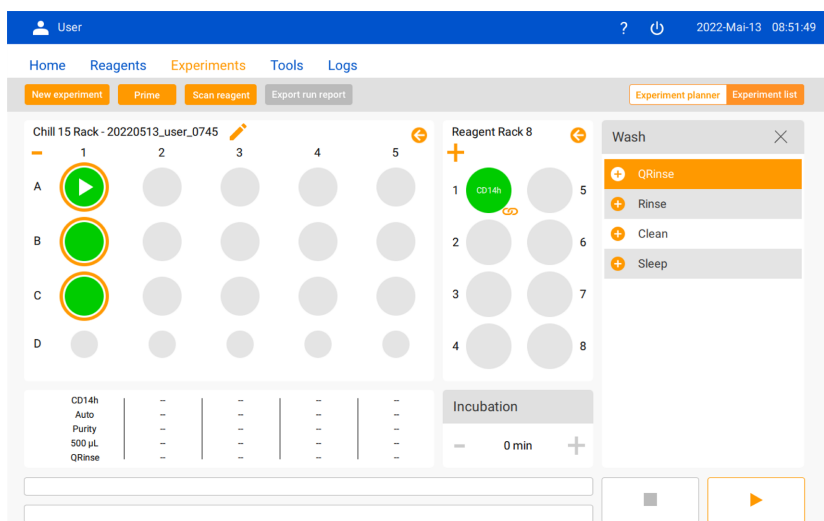

- 15 If desired, add further reagents or samples.
- 16 Unscrew the lids from the reagent vials and place the vials onto the designated positions on the MACS Reagent Rack 8.
- 17 For further proceeding, see chapter **Placing the tubes on page 55**.

## 6.2.2 Manual labeling

It is recommended to store the MACS Chill Racks in the refrigerator at +2 to +8 °C until the coolant switched into solid state. Depending on the refrigerator and rack type, it takes at least 3 hours until the coolant switches into solid state. Do not cool below 0 °C, as samples may freeze.

- 1 Follow the labeling instructions in the data sheet of the cell separation reagent.
- 2 Place the Chill Rack on the MACS MiniSampler S.
- 3 Select the same Chill Rack in the **Experiments** tab. An experiment is created automatically. The default experiment name is shown next to the rack name.
- 4 Tap a position on the sample rack. An orange outline around the position indicates that it is selected.

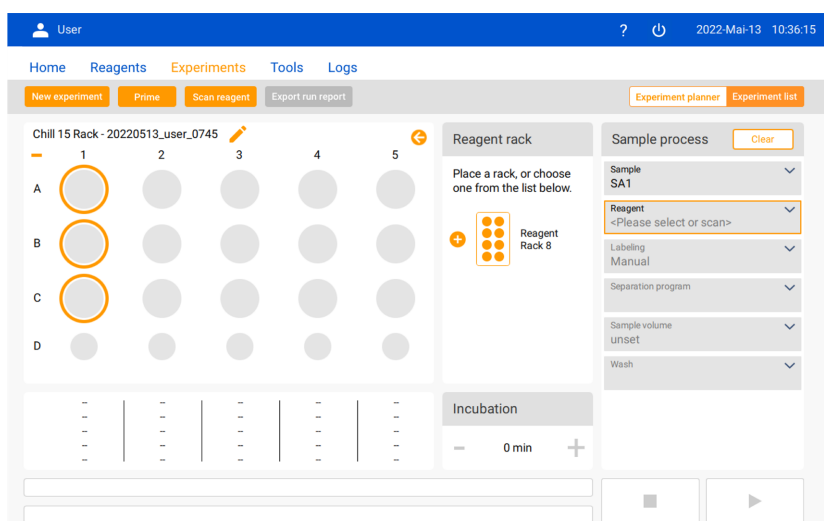

- 5 Optional: Enter a custom sample name, see chapter **Assigning custom sample names on page 66**.

- 6 If the reagent has no barcode, tap **Reagent** in the **Sample process** pane. The 15 most recently selected reagents are displayed. Select a reagent or tap **More reagents...** to go to the **Reagents** tab, see chapter **Using the Reagents tab on page 68**.
- 7 If the reagent has a barcode, scan the code as described in chapter **Scanning reagents on page 61**.
- 8 The reagent is now added to the sample process. Manual labeling is set automatically.

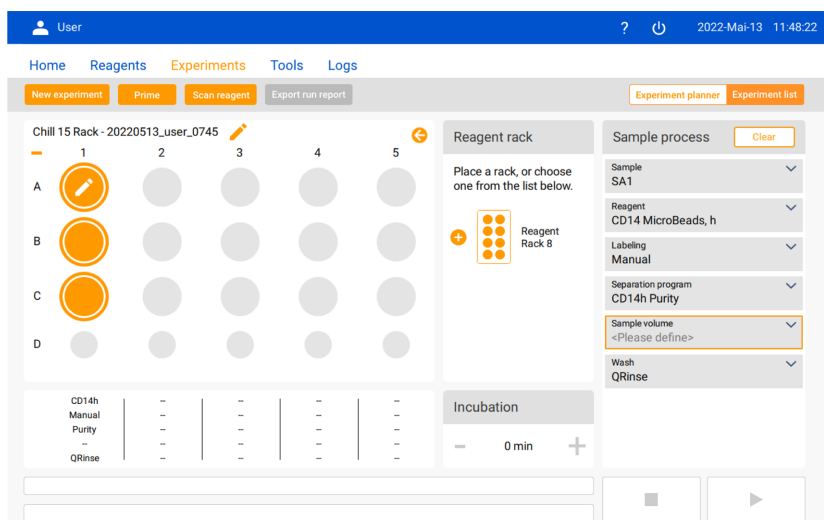

- 9 If desired, tap **Separation program** in the **Sample process** pane to change the preset separation program. See **autoMACS NEO separation programs on page 73** for details.
- 10 Tap **Sample volume**. The possible sample volume range is shown.

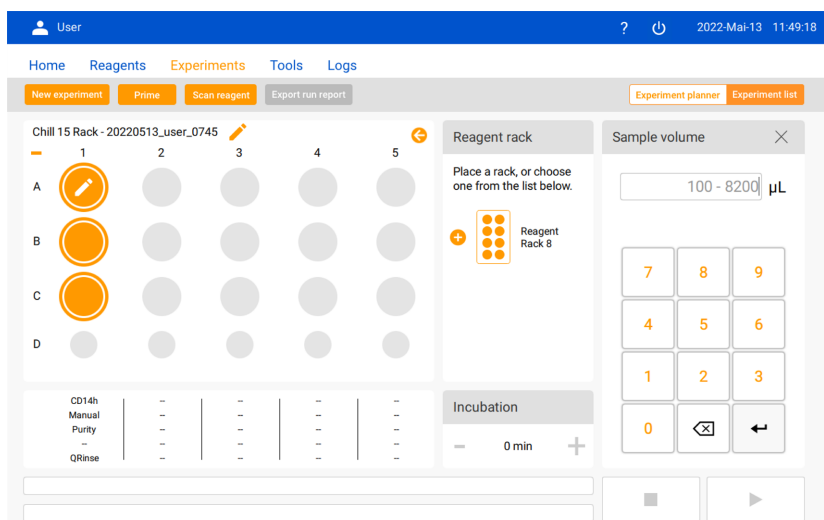

- 11 Enter the sample volume and tap the return key. The sample position color changes to green and the **Ready for processing** symbol is shown in sample position A1 (**Table 8.3**).



- 12 If desired, change the preset wash program. Tap **Wash** and select a wash program to be run after the separation. For more information on the available wash programs, see chapter **Washing and maintenance programs on page 89**.

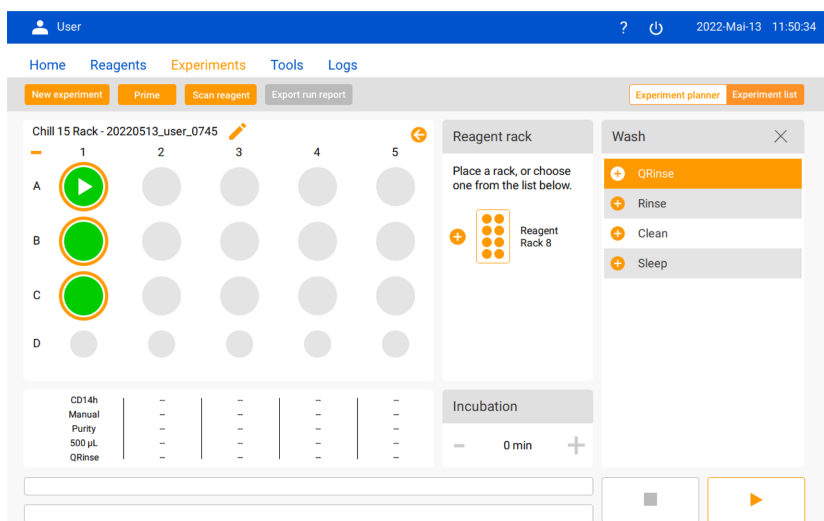

- 13 If desired, add further samples.
- 14 If needed, enter an incubation time for the experiment. For details, see chapter **Setting an incubation time for manual labeling on page 63**.

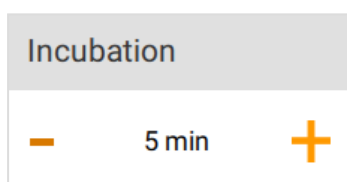

- 15 For further proceeding, see chapter **Placing the tubes below**.

## 6.3 Placing the tubes

- 1 Place the samples and empty tubes for the labeled and unlabeled fractions respectively.
- 2 For further proceeding, see chapter **Running an experiment on page 67** or **Function options for setting up an experiment on the next page**.

### 6.3.1 Correct order for placing tubes

For all reagents and kits except REAlease Kits place the tubes in the following order unless specified otherwise in the reagent data sheet.

- Row A of the Chill Rack holds the sample tubes.
- Row B of the Chill Rack holds empty tubes for the unlabeled (negative) fractions.
- Row C of the Chill Rack holds empty tubes for labeled (positive) fractions.
- Optionally: Row D can hold round-bottom tubes for further analysis.

When using REAlease Kits place the tubes in the following order unless differently specified in the reagent data sheet.

- Row A of the Chill Rack holds the sample tubes.
- Row B of the Chill Rack holds empty tubes for the unlabeled (negative) fractions.
- Row C of the Chill Rack holds empty tubes for incubation with REAlease Beads Release Reagent.
- Row D of the Chill Rack holds empty tubes for biotinylated target cells.

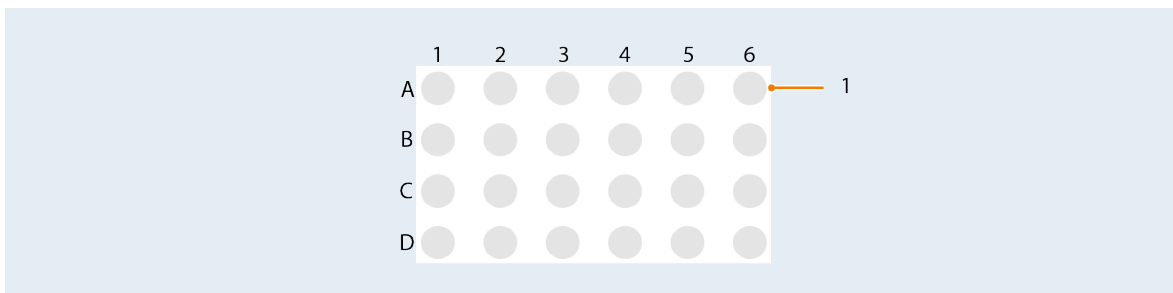

**Figure 6.1:** Rows and columns of the Chill 5 Rack with 5 mL tubes

1 5 mL tubes

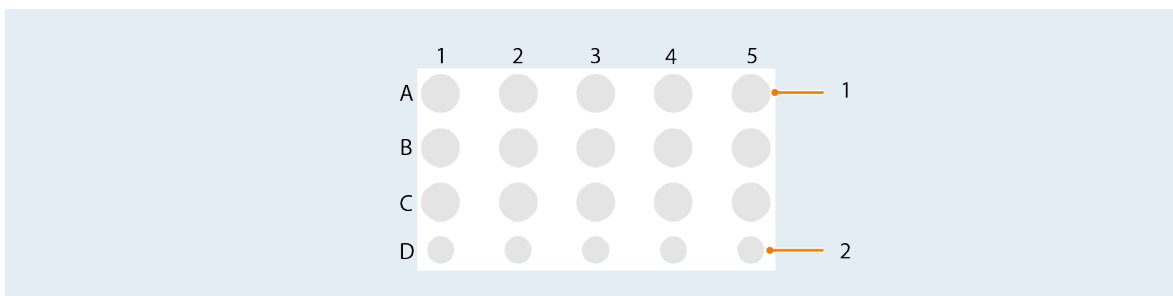

**Figure 6.2:** Rows and columns of the Chill 15 Rack

1 15 mL tubes

2 5 mL tubes

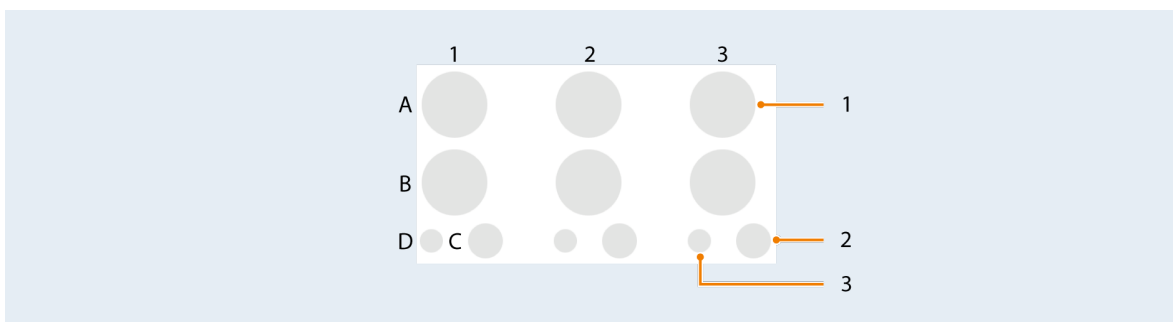

**Figure 6.3:** Rows and columns of the Chill 50 Rack

1 50 mL tubes

3 5 ml tubes

2 15 mL tubes

## 6.4 Function options for setting up an experiment

There are several options to define the experiment as described.

- **Selecting and deselecting sample and reagent positions on the facing page**
- **Assigning a reagent to a sample on page 58**
- **Assigning a sample to a reagent on page 59**
- **Scanning reagents on page 61**
- **Copy an assigned separation process to a new sample on page 61**
- **Changing the labeling method on page 62**
- **Setting an incubation time for manual labeling on page 63**

- **Adding lot number and expiration date on page 63**
- **Deleting samples on page 65**
- **Deleting autolabeling reagents on page 65**
- **Deleting manual labeling reagents on page 65**
- **Changing the rack type on page 65**
- **Assigning custom experiment names on page 66**
- **Assigning custom sample names on page 66**

For further proceeding, see chapter **Running an experiment on page 67**.

### 6.4.1 Selecting and deselecting sample and reagent positions

Selected positions in the **Sample rack** pane and **Reagent rack** pane are highlighted by an orange outline. If a sample position is selected, the respective sample process definition is shown in the **Sample process** pane. If a reagent is selected, the reagent details are shown in the **Reagent details** pane.

The **Sample process** pane displays the following information related to the selected position(s):

Name	Function
<b>Sample</b>	Displays the name of the active sample.
<b>Reagent</b>	Selection of a reagent including a specified process.
<b>Labeling</b>	Selection of manual labeling or autolabeling. Depending on the reagent one or both labeling methods are available.
<b>Separation program</b>	Selection of the cell separation program (Default: <b>Purity</b> ).
<b>Sample volume</b>	Input field for the sample volume.
<b>Wash</b>	Selection of a wash program that shall be run after the separation of the sample (Default: the optimal wash program for the specific thing is preset as default).

**Table 6.1:** Information in the **Sample process** pane.

The **Reagent details** pane displays the following information related to the selected position(s):

Name	Function
<b>Reagent</b>	Name of the reagent.
<b>Species</b>	Species whose cells can be separated with the selected reagent.
<b>Separation strategy</b>	Separation type of the selected reagent.
<b>Components</b>	Components of the selected reagent.
<b>Lot no.</b>	Lot number. Possibility to enter the lot number manually.
<b>Expiration date</b>	Expiration date. Possibility to enter the expiration date manually.

**Table 6.2:** Information in the **Reagent details** pane .

Tap a position to select or deselect it. Select several positions by tapping one position after another. To select all positions, tap the plus sign at the upper left corner. If one position is selected, the plus sign changes into a minus sign. To deselect all positions, tap the minus sign at the upper left corner.

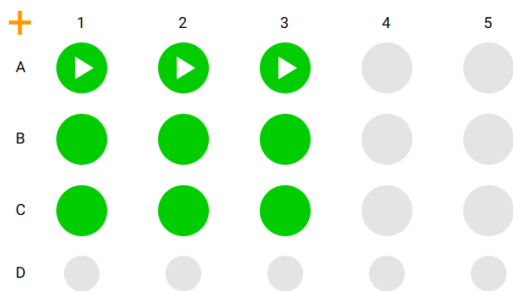

Figure 6.4: Sample rack pane, all positions are deselected.

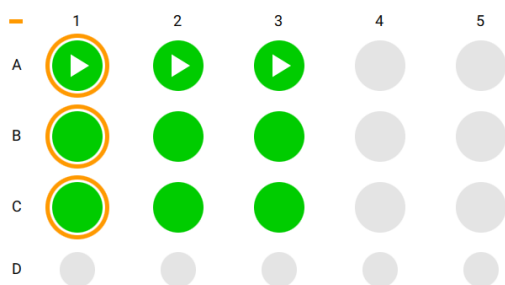
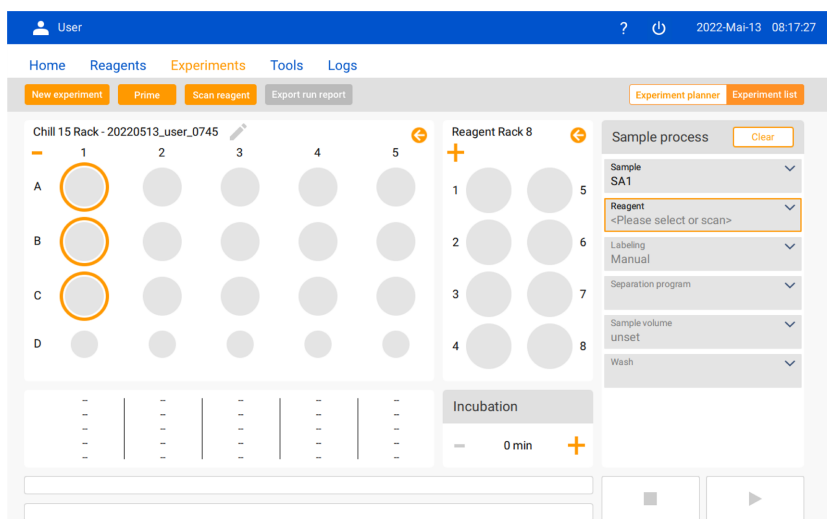

Figure 6.5: Sample rack pane, the first position is selected.

## 6.4.2 Assigning a reagent to a sample

This function applies only to autolabeling.

- 1 Tap the position on the sample rack you want to assign a reagent. An orange outline around the position indicates that it is selected.



- 2 If the reagent has no barcode, tap **Reagent** in the **Sample process** pane. The 15 most recently selected reagents are displayed. Select a reagent or tap **More reagents...** to go to the **Reagents** tab, see chapter **Using the Reagents tab on page 68**.
- 3 If the reagent has a barcode, scan the code as described in chapter **Scanning reagents on page 61**.
- 4 A dialog box specifies the position of the reagent on the reagent rack. The reagent is placed on the first free position on the reagent rack. Tap **Place reagent(s) on Reagent Rack**.

- 5 A dialog box specifies the position of the reagent on the reagent rack. The reagent is placed on the first free position on the reagent rack. Tap **Place reagent(s) on Reagent Rack**.

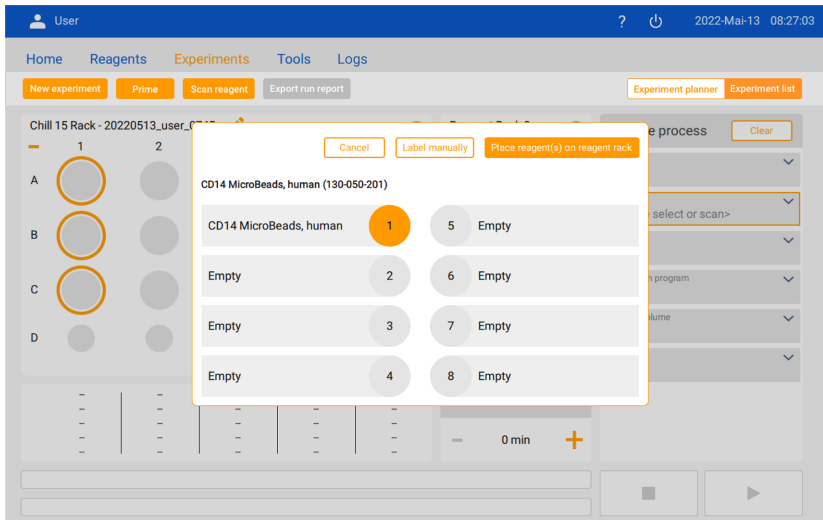

- 6 The reagent is now visible on the selected position and is assigned to your sample which is indicated by the link symbol next to the reagent.

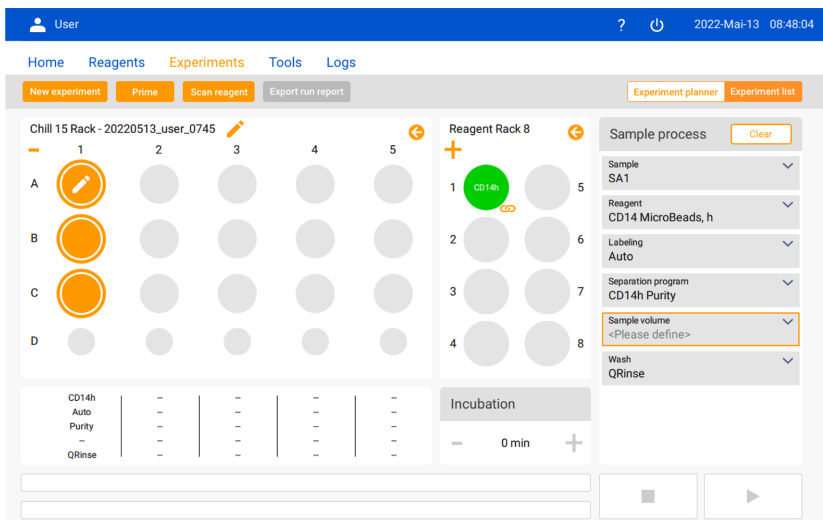

### 6.4.3 Assigning a sample to a reagent

This function applies only to autolabeling.

- 1 If the reagent has no barcode, tap **Reagent** in the **Sample process** pane. The 15 most recently selected reagents are displayed. Select a reagent or tap **More reagents...** to go to the **Reagents** tab, see chapter **Using the Reagents tab on page 68**.
- 2 If the reagent has a barcode, scan the code as described in chapter **Scanning reagents on page 61**.

- 3 A dialog box specifies the position of the reagent on the reagent rack. The reagent is placed on the first free position on the reagent rack. Tap **Place reagent(s) on Reagent Rack**.

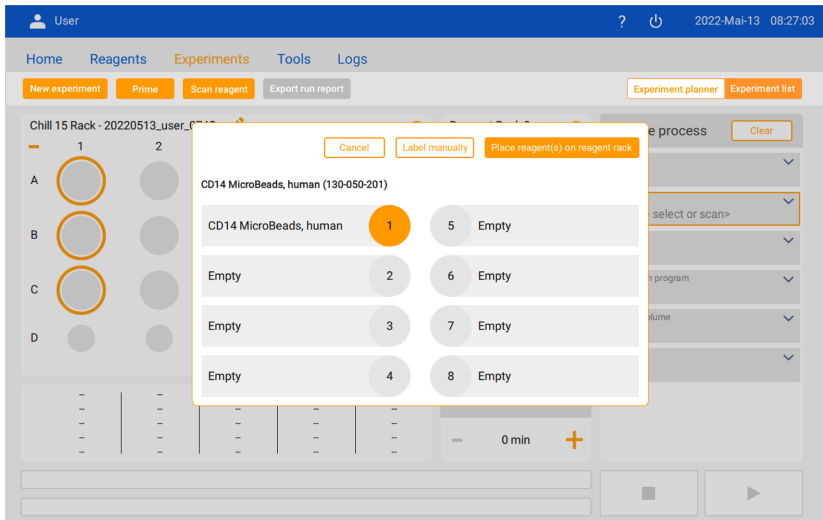

- 4 The reagent is now placed on the reagent rack. Tap the position to select it.

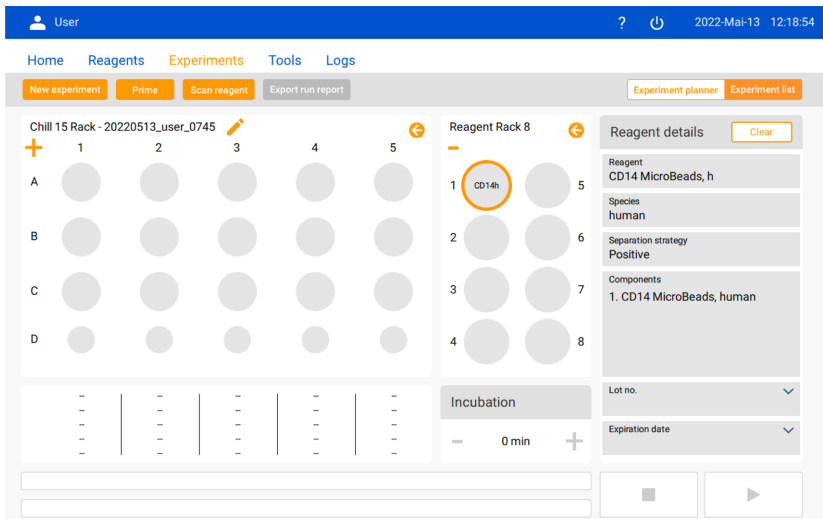

- 5 Tap the sample position you want to assign. The link symbol appears next to the sample.

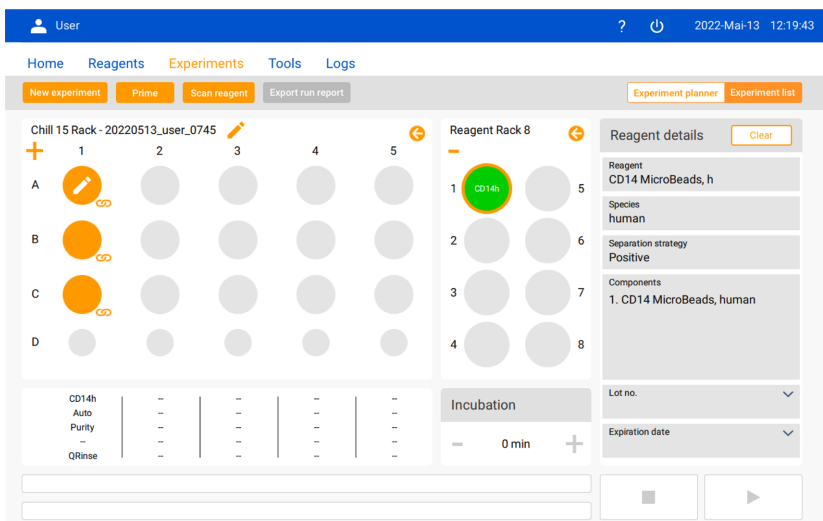

## 6.4.4 Scanning reagents

Selected reagents are provided with a barcode on their label. You can use the barcode reader of the autoMACS NEO Separator to add them to your experiment. Reagents without barcode must be added manually.

### Scan reagent

- 1 Tap the **Scan reagent** button in the toolbar. The button is visible in the **Home** tab, the **Experiments** tab, and the **Reagents** tab. The scan function is now active for 30 seconds.
- 2 Hold the barcode of the reagent vial in front of the barcode reader. If you have a kit, scan any component of the kit.
- 3 When the barcode has been successfully detected, a dialog box opens. The reagent is placed on the first free position of the reagent rack. A warning sign is displayed if the reagent is expired.

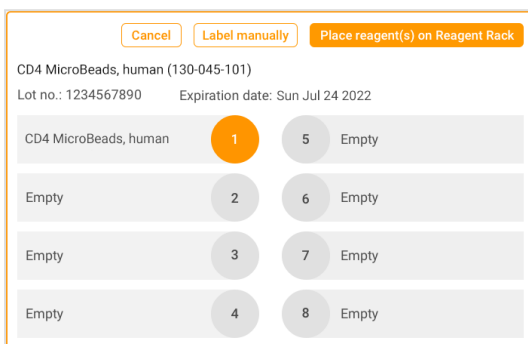

- 4 Tap **Place reagent(s) on Reagent Rack**.
- 5 Unscrew the lids of the vials.
- 6 Place the kit components on the reagent rack as indicated in the dialog box.

If the scan function is used, the lot number and expiration date of the reagent will be read out and saved automatically in the experiment.

## 6.4.5 Copy an assigned separation process to a new sample

- 1 Tap and hold the position of the **Sample rack** pane that you want to copy. The orange outline around this position starts to blink.
- 2 Tap one or more empty positions of the **Sample rack** pane. The positions are now selected.
- 3 Tap the position of the position of the **Sample rack** pane to be copied again. The separation process is copied.

## 6.4.6 Changing the labeling method

### From autolabeling to manual labeling

- 1 Select the sample position you want to change the labeling method for.
- 2 Change the parameter **Labeling** in the **Sample process** pane to **manual**. The link symbol next to the reagent disappears and the color of the reagent position turns to gray if no other sample uses this reagent for autolabeling. The reagent remains on the rack.

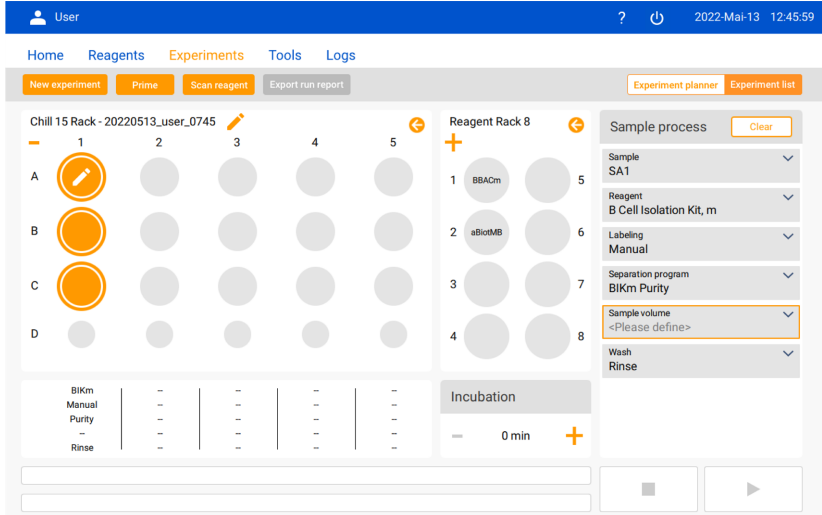

- 3 Enter the sample volume for manual labeling.

### From manual labeling to autolabeling

Autolabeling is not available for all reagents. In these cases, the labeling method cannot be changed. To find out whether a reagent is autolabeling compatible, consult the respective data sheet or visit [www.miltenyibiotec.com/automacs-neo-sample-processing](http://www.miltenyibiotec.com/automacs-neo-sample-processing).

- 1 Place a MACS Reagent Rack 8 on the MACS MiniSampler S and select it in the **Reagent rack** pane.
- 2 Change the parameter **Labeling** in the **Sample process** pane to autolabeling.
- 3 A dialog box specifies the position of the reagent on the reagent rack. The reagent is placed on the first free position on the reagent rack. Tap **Place reagent(s) on Reagent Rack**.

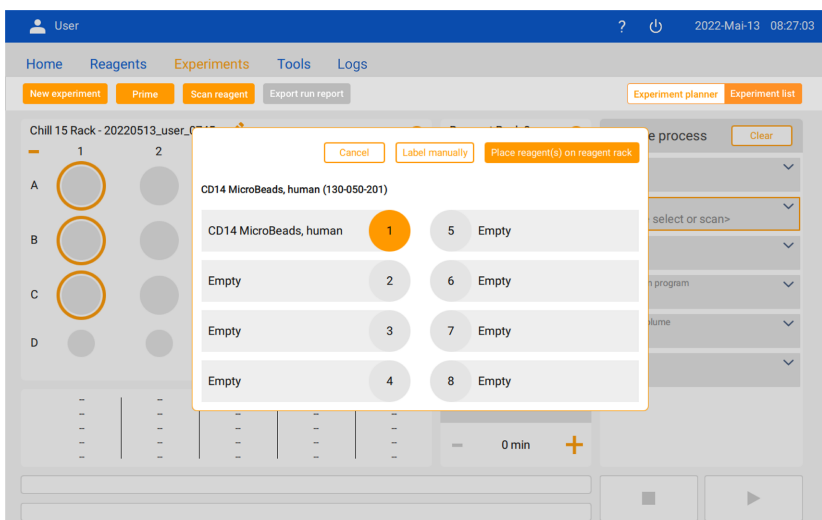





- The reagent is now visible on the selected position and is assigned to your sample, which is indicated by the link symbol next to the reagent.

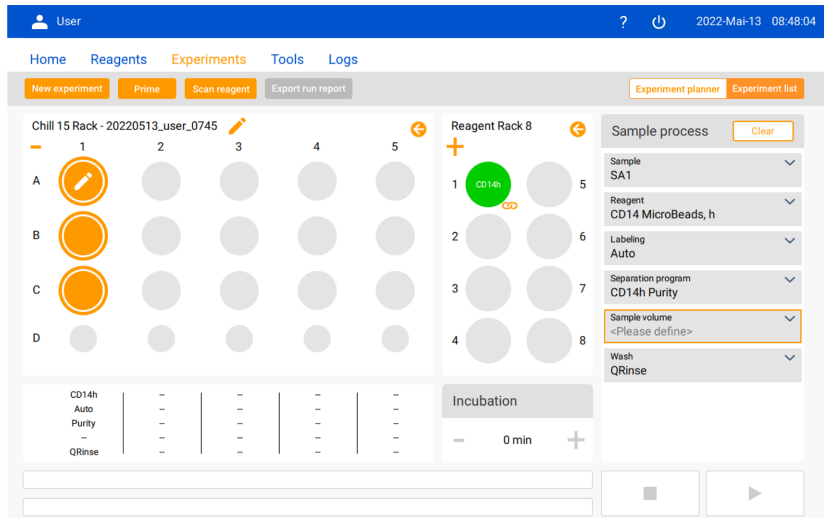

- Enter the sample volume for autolabeling.

### 6.4.7 Setting an incubation time for manual labeling

Some experiments with manual labeling do not require a wash step after labeling. For these experiments an incubation time can be set and the incubation can be performed on the instrument. Consult the data sheet of the respective reagent to find out whether the washing step after labeling is optional.

The instrument waits once before separation of the first sample. When processing autolabeling and manual labeling samples in one experiment, the separation start will be delayed also for the autolabeling samples. This may increase the experiment duration.

- Define your experiment.
- Set the incubation time in the respective **Experiments** tab. Tap the plus or minus sign to adjust the value.

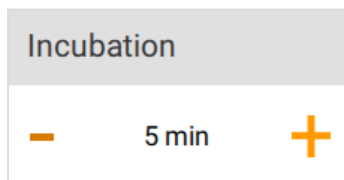

- Tap the **Run** button to start the experiment. The separation will start after the incubation has ended.

### 6.4.8 Adding lot number and expiration date

If the scan function is used, the lot number and expiration date of the reagent are read out automatically from the reagent barcode and saved in the experiment. If the reagent is selected manually or if you want to update the reagent lot of a previously defined experiment, you have the option to manually add this information to the reagent details.

1 Select a reagent on the reagent rack. The reagent details are shown.

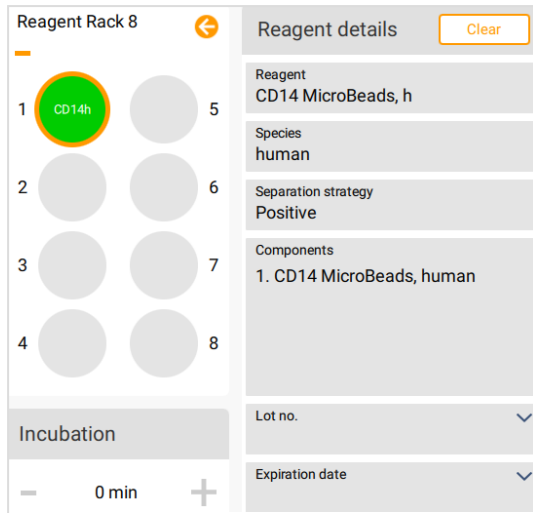

2 Tap **Lot no.** to open the number pad.

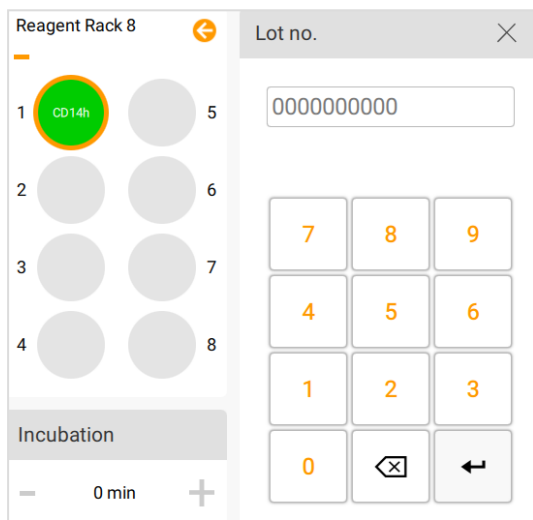

3 Enter the lot number and tap the return key.

4 Tap **Expiration date** to open the number pad.

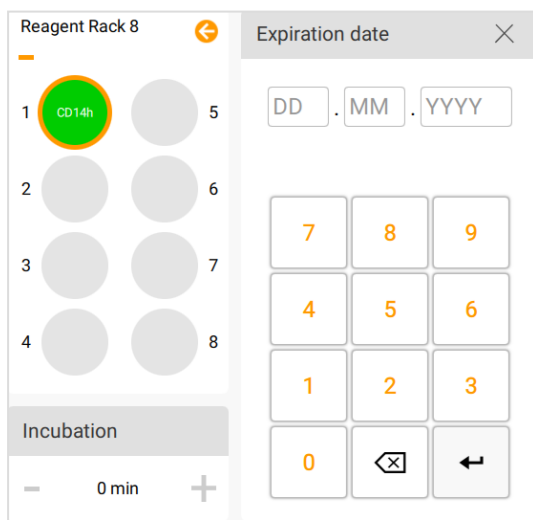

5 Enter the expiration date and tap the return key.

### 6.4.9 Deleting samples

- 1 Select the respective positions on the sample rack. The **Sample process** pane is shown.
- 2 Tap **Clear** in the upper right corner of the **Sample process** pane. A message box appears.
- 3 Tap **Clear** in the message box. The sample is deleted.

If a reagent is assigned for autolabeling to the deleted sample, the reagent will remain on the reagent rack (**Figure 6.6**). A new sample can be easily assigned by tapping the respective sample position.

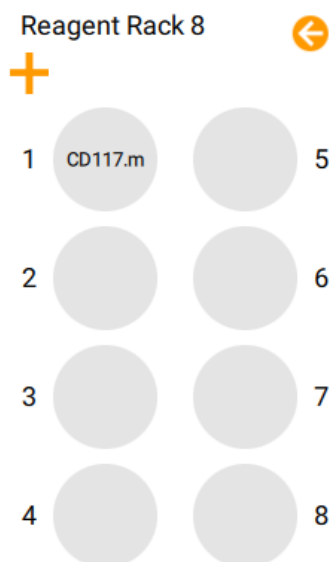

**Figure 6.6:** Remaining reagent after deletion of the assigned sample.

### 6.4.10 Deleting autolabeling reagents

- 1 Select the respective position on the reagent rack. The **Reagent details** pane is shown.
- 2 Tap **Clear** in the upper right corner of the **Reagent details** pane. A message box appears.
- 3 Tap **Clear** in the message box. The labeling method for the assigned samples changes to manual labeling.
- 4 Assign a different reagent for autolabeling, see chapter **Assigning a reagent to a sample on page 58**.

### 6.4.11 Deleting manual labeling reagents

- 1 Tap Reagent in the **Sample process** pane. The **Reagent details** pane opens.
- 2 Tap **Clear** in the upper right corner of the **Reagent details** pane. A message box appears.
- 3 Tap **Clear** in the message box to confirm the deletion.
- 4 Assign a different reagent, see chapter **Assigning a reagent to a sample on page 58**.

### 6.4.12 Changing the rack type

You can change the selected sample rack or remove the reagent rack as follows:

- 1 Tap the left arrow button in the upper right corner of the **Sample rack** pane or **Reagent rack** pane. A message box appears. When changing a sample rack all defined sample processes get lost. When removing the reagent rack all reagents are removed and the labeling method of affected samples changes to manual labeling.
- 2 Confirm with **Change** to return to the rack selection.

### 6.4.13 Assigning custom experiment names

When an experiment is created, an experiment name is created automatically and displayed above the sample rack in the user interface. The default experiment name is **YYMMDD\_userID\_hhmm** (Figure 6.7).

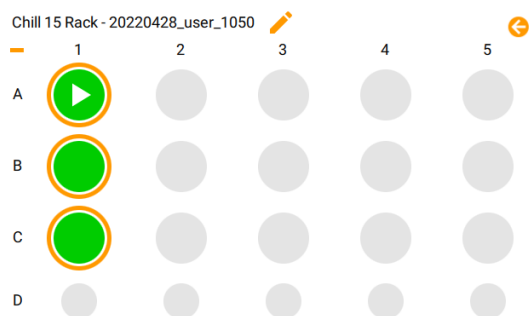

**Figure 6.7:** Sample rack with experiment name.

To change the experiment name, do the following:



- 1 Tap the pen symbol next to the experiment name. The keyboard appears.
- 2 Edit the experiment name.

Chill 15 Rack - 20220428\_user\_1050

- 3 Tap the return key.

### 6.4.14 Assigning custom sample names

When a sample position is selected, a sample name is generated automatically. According to the number of the selected row in the rack the default sample name is SA1, SA2, etc.

To change the sample name do the following:

- 1 Tap **Sample** in the **Sample process** pane. The keyboard opens.

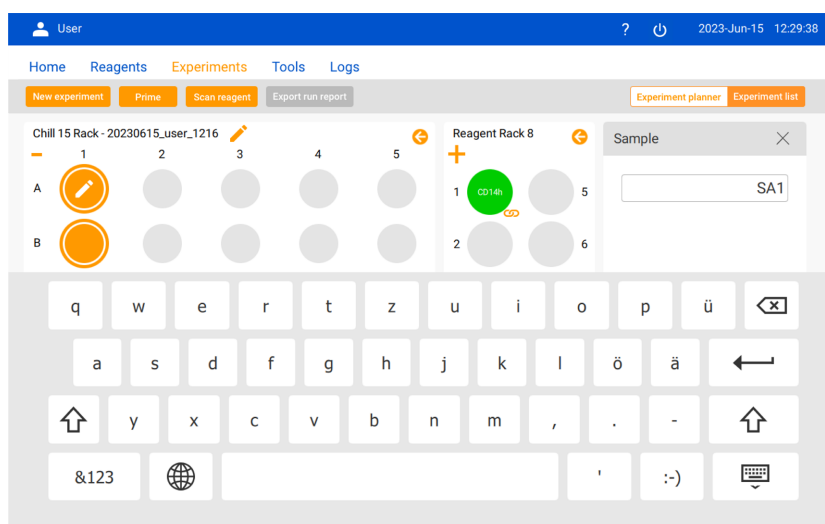

- 2 Enter a new sample name with maximum 24 characters.
- 3 Tap the return key to save.

## 6.5 Running an experiment

- 1 Go to the **Experiments** tab.
- 2 In the **Experiment planner**, check all settings in the summary table and make sure that the desired sample process details are selected. Check if all vials and tubes are placed in correct order.

To check if the positions of the samples and reagents are assigned correctly, tap one position. The assigned position is marked with a link symbol.

- 3 Tap the **Run** button to start the experiment.

## 6.6 Stopping an experiment

- 1 To stop a current experiment, tap the **Stop** button in the progress bar. A message appears.
- 2 Confirm stopping or continue the experiment.
- 3 Optional: After stopping, the experiment can be restarted from the beginning. If the experiment is stopped after sample uptake, a message appears. Decide if the sample shall be discarded or rescued, see chapter **Disruption of processes on page 116**.

## 6.7 Using the Experiment list

The **Experiment list** shows a list of all experiments that are in preparation, ready for processing, processing, finished, failed, or canceled. Experiments can be filtered by their status (**Table 8.5**).

Entries in the **Experiment list** can be deleted. Users can only delete their own experiments. Administrators can delete experiments of all users.

- 1 Go to the **Experiments** tab.
- 2 Switch to the **Experiment list** via the respective button on the right-hand side of the toolbar.

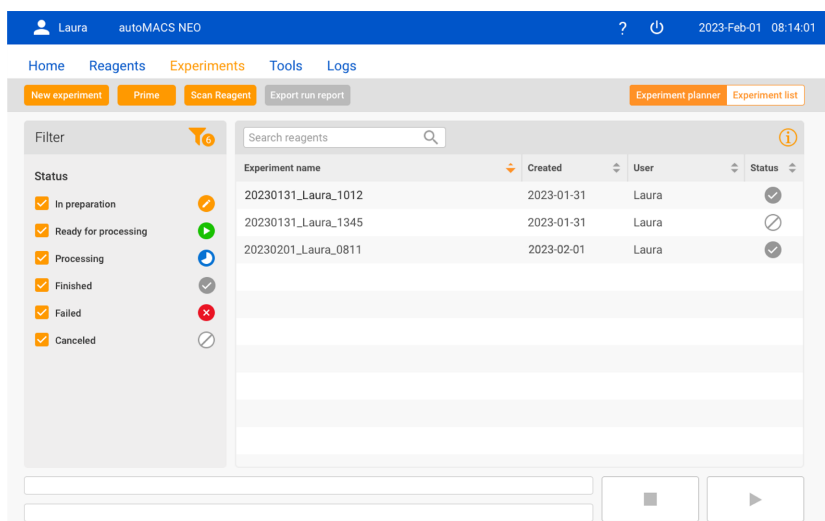

- 3 Filter the **Experiment list** by the experiment status or use the search bar for full-text search. Sort the results by experiment name, creation date, user, or status.
- 4 Tap the desired experiment line. A details box appears.
- 5 Tap **Open**. The experiment opens in the **Experiment planner**.
- 6 Edit the experiment or tap the **Run** button to start the experiment.

## 6.8 Using the Reagents tab

To open the **Reagents** tab (**Figure 6.8**), use one of these options:

- Tap **Reagent > More reagents...** in the **Sample process** pane.
- Tap a free position on the reagent rack.
- Tap **Reagents** in the title bar.

The reagents tab contains all reagents that are suitable for separations with the autoMACS NEO Separator. Reagents can be filtered by species, cell type, separation strategy, and technology by checking the boxes on the left side. A search bar above the reagent list allows for full-text search. The results can be sorted by reagent name, order number, and cell type.

If a reagent is selected, a **Details** box is shown with the following information about the reagent:

- reagent name
- order number
- cell type
- species
- list of components supplied with the reagent
- separation strategy

To add reagents to an experiment, tap the plus sign to the left of the reagent name. Alternatively tap **Add** in the **Details** box.

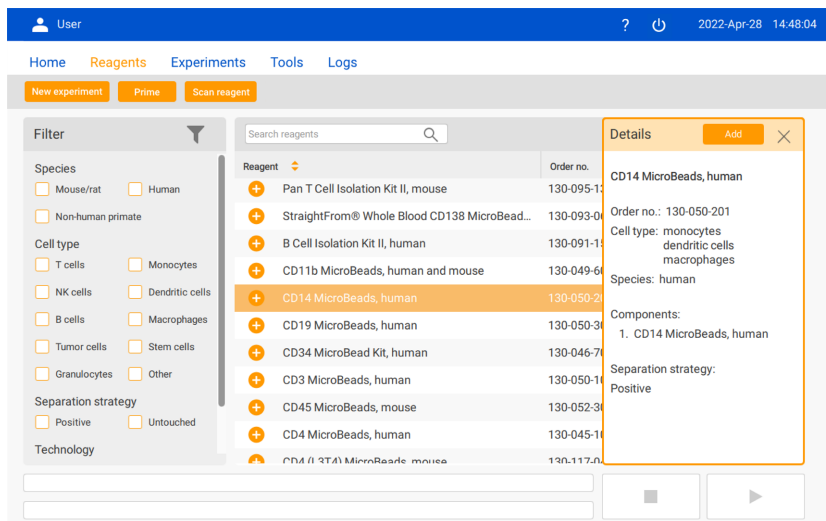

**Figure 6.8:** Reagents tab with open **Details** box.

## 6.9 Exporting a run report

You can export a report for finished, canceled, and failed experiments to an USB flash drive. The report is exported to the root folder of the USB flash drive. The experiment name is used as filename for the exported file.

Users can only export reports of their own experiments. Administrators can export reports of all experiments.

- 1 Insert a USB flash drive into one of the USB ports of the touchscreen.
- 2 Go to the **Experiments** tab.
- 3 Select an experiment from the **Experiment list** or open an experiment in the **Experiment planner**. The **Export run report** button in the toolbar is now active.
- 4 Tap the **Export run report** button. The export starts immediately.
- 5 Wait. A message box appears when the export has been finished.
- 6 Remove the USB flash drive.





# 7

## Cell separation

### 7.1 Preparing single-cell suspensions

Cell aggregates may contain mixtures of target and non-target cells and can clog the column. Therefore, they can impair the separation results.

- Use autoMACS Running Buffer - MACS Separation Buffer during sample handling steps to minimize the risk of cell aggregation.
- Resuspend cells carefully after centrifugation.
- Use Pre-Separation Filters, 30 µm (# 130-041-407) or Pre-Separation Filters, 70 µm (# 130-095-823) to remove cell aggregates that may clog the column. Large cell aggregates may interfere with the separation process and may cause pressure variations in the fluidic system of the instrument.
- Consult the respective cell separation reagent data sheet for specific recommendations on the preparation of single-cell suspensions.

### 7.2 Labeling methods

After preparing single-cell suspensions, proceed with magnetic labeling. Most cell separation reagents can be used for manually labeling your samples and subsequent separation on the autoMACS NEO Separator (exception: REAlease Kits), see respective reagent data sheets for details.

Alternatively, for many reagents magnetic labeling can be conducted fully automated by the autoMACS NEO Separator. For a current list of cell separation reagents that are compatible with autolabeling prior to cell separation with the autoMACS NEO Separator, contact Miltenyi Biotec Technical Support or visit [www.miltenyibiotec.com/automacs-neo-sample-processing](http://www.miltenyibiotec.com/automacs-neo-sample-processing).

### 7.3 Sample volumes

Depending on the starting material, the separation technology, and the labeling method used, different cell numbers and/or sample volumes can be handled on the instrument.

To get an overview about the sample volumes for each starting material (**Table 7.1**). The table shows the minimal and maximal sample volumes depending on the Chill Rack used.

We do not recommend working with fewer than  $2 \times 10^7$  cells. The dilution required for every reagent can also be found in the respective reagent data sheet.

We do not recommend working with cell numbers exceeding  $2 \times 10^8$  labeled and/or  $4 \times 10^9$  total cells in a single sample tube. When working with higher cell numbers, split your sample to several sample tubes to achieve optimal results. Alternatively, for an increasing number of reagents the autoMACS NEO Separator offers a feature to exceed column capacity without the need to split the sample to several tubes. This feature is termed

stage loading, see **Stage loading for samples exceeding the column capacity below** for details. Exceeding the limitations of the autoMACS Column with reagents for which stage loading is not offered, will lead to a reduced quality of your target cells.

Rack type	Max sample no.	Slots	Volume of PBMCs and dissociated tissue		Volume of whole blood, bone marrow, and buffy coat	
			Min <sup>1</sup>	Max <sup>1</sup>	Min <sup>2</sup>	Max <sup>2</sup>
Chill 5 Rack	6 (5 mL tubes)	24×5 mL	0.1 mL	2.5 mL	0.25 mL	1.7 mL
Chill 15 Rack	5 (15 mL tubes)	15×15 mL 5×5 mL	0.5 mL	10.5 mL	0.5 mL	7.0 mL
Chill 50 Rack	3 (50 mL tubes)	6×50 mL 3×15 mL 3×5 mL	2.0 mL	42.0 mL	2.0 mL	28.0 mL

**Table 7.1:** Chill Rack specifications according to the starting material.

<sup>1</sup> Labeling volume (sample volume including reagent volume)

<sup>2</sup> Original volume (undiluted sample volume)

Minimal volumes represent recommended minimal volumes. Maximal volumes can technically be handled by the instrument.

## 7.4 Stage loading for samples exceeding the column capacity

The maximum capacity of an autoMACS Column is  $2 \times 10^8$  labeled cells and  $4 \times 10^9$  total cells per sample.

The autoMACS NEO Separator provides stage loading as a feature to exceed the maximum capacity of labeled cells within a single sample. During this procedure the instrument applies the sample onto the column in multiple aliquot portions, called stages, not exceeding the cell capacity of the column. Thus, larger samples can be processed from a single tube without pre-aliquoting the sample to several tubes.

As the frequency of the labeled cells is depending on the starting material, the reagent, the species, and other factors, the suitable stage volume to reach the column capacity differs for each reagent. The possible volume range between the minimal required and maximum possible volume for a particular reagent is calculated automatically by the instrument and is displayed when a reagent is selected in the **Experiment planner**. If the cell capacity is exceeded, stage loading will automatically be activated to process the sample. During the experiment run the currently processed stage is displayed in the progress bar.

Stage loading is available for several reagents. In order to find out whether stage loading is available for the reagent of your interest, visit [www.miltenyibiotec.com/automacs-neo-sample-processing](http://www.miltenyibiotec.com/automacs-neo-sample-processing) or contact Miltenyi Biotec Technical Support.

## 7.5 autoMACS NEO separation programs

### Default programs

The autoMACS NEO Separator provides several programs with different flow speeds through the column(s). The flow speed influences the purity and recovery of the separated fractions.

For every reagent, reagent-specific optimized programs are suggested by default. The autoMACS NEO Separator provides default separation programs with different priorities, such as **Purity**, **Recovery**, and **Depletion** (Table 7.2). These are shown as reagent short name and focus, e.g., **CD41Kh Purity** or **CD41Kh Recovery**. Not all programs are available for each reagent. A separation program achieving highest target cell purity is available and set by default. Consult the reagent data sheet for details. You can find available programs also via the **Sample process** pane after selection of a reagent, see chapter **Selecting and deselecting sample and reagent positions on page 57**.

Name	Focus of the program
<b>Purity</b> (default)	Highest target cell purity
<b>Recovery</b>	Highest target cell yield
<b>Depletion</b>	Depletion of labeled population from sample

**Table 7.2:** Default separation programs provided by the autoMACS NEO Separator.

### Advanced programs

For further adjustment, advanced programs can be selected. Advanced programs are classified into single column programs, double column programs, and special programs. A drop-down menu shows the different separation programs in the respective category, see **Figure 7.1**. Single column programs require one autoMACS Column. Double column programs run through two columns for maximal purity of labeled cells and require two columns to be installed. Program names indicate the speed of sample uptake onto the column(s). Select a program slower or faster than the recommended programs, depending on the desired results. See **Figure 7.2** for the correlation between purity, recovery, and the uptake speed. Default programs are also listed and can be identified by the priority in the program name.

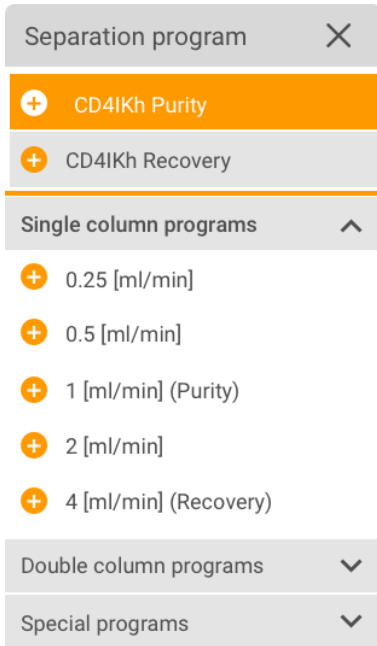

**Figure 7.1:** Example of single column programs, with default programs **1 [ml/min] Purity** and **4 [ml/min] (Recovery)**.

### Special programs

Special programs pre-dilute samples, e.g., whole blood programs (WB), or require alternative buffers (BU).

Target cells?	Downstream application requires ...?	Columns	Uptake speed	Separation program name
Labeled cells (=positive selection)	<div style="display: flex; justify-content: space-around; align-items: center;"> <div style="text-align: center;"> <span style="font-size: 2em;">+</span> Purity <span style="font-size: 2em;">-</span> </div> <div style="text-align: center;"> <span style="font-size: 2em;">-</span> Recovery <span style="font-size: 2em;">+</span> </div> </div>	2	4 [mL/min] (Column 1), 4 [mL/min] (Column 2)	4/4 [mL/min]
			4 [mL/min] (Column 1), 2 [mL/min] (Column 2)	4/2 [mL/min]
		1	8 [mL/min]	8 [mL/min]
			6 [mL/min]	6 [mL/min]
			4 [mL/min]	4 [mL/min]
			3 [mL/min]	3 [mL/min]
			2 [mL/min]	2 [mL/min]
			1 [mL/min]	1 [mL/min]
			0.5 [mL/min]	0.5 [mL/min]
			0.25 [mL/min]	0.25 [mL/min]
Unlabeled cells (=negative or untouched selection)	<div style="display: flex; justify-content: space-around; align-items: center;"> <div style="text-align: center;"> <span style="font-size: 2em;">+</span> Purity <span style="font-size: 2em;">-</span> </div> <div style="text-align: center;"> <span style="font-size: 2em;">-</span> Recovery <span style="font-size: 2em;">+</span> </div> </div>	1	0.25 [mL/min]	0.25 [mL/min]
			0.5 [mL/min]	0.5 [mL/min]
			1 [mL/min]	1 [mL/min]
			2 [mL/min]	2 [mL/min]
			4 [mL/min]	4 [mL/min]
			6 [mL/min]	6 [mL/min]
			8 [mL/min]	8 [mL/min]

**Figure 7.2:** Correlation between purity, recovery, and the uptake speed depending on the respective target cell fraction.

# 8

## Monitoring the instrument

### 8.1 Touchscreen LED

The touchscreen of the autoMACS NEO Separator has an LED at the lower-left corner. The color of the LED indicates the instrument status (**Table 8.1**).

Color	Frequency	Status
Off	Static	Instrument is switched off.
White	Static	Standby mode, no wakeup scheduled.
Green	Dim on and off	Standby mode, wakeup scheduled.
Green	Blinking	Instrument is starting up.
Green	Static	Instrument is running.
Red	Static	Hardware error detected.

**Table 8.1:** Color-coding of the touchscreen LED.

### 8.2 Fluid bottle illumination







The autoMACS NEO Separator has LEDs that illuminate each bottle to indicate the status of the instrument (**Table 8.2**).

Color	Frequency	Bottle	Status
Green	Static	All bottles	Instrument is ready for separation. No action required.
Green	Blinking	All bottles	Instrument is not ready for separation. Specific process or action required.
Blue	Static	All bottles	Instrument is running.
Red	Static	All bottles	Hardware error detected.
Red	Blinking	All bottles	Process error detected.
Red	Blinking	All bottles	Liquid level error detected.

**Table 8.2:** Fluid bottle illumination status.

### 8.3 Coding of the sample positions

The sample positions are color-coded and symbol-coded to indicate their current status (**Table 8.3**).

	<b>In preparation</b>	Sample is in preparation.
	<b>Ready for processing</b>	A process is assigned and the sample is ready to be processed.
	<b>Pending</b>	Experiment has been started but the sample is not yet being processed.
	<b>Processing</b>	Sample is being processed.
	<b>Finished</b>	Separation of the sample successfully finished.
	<b>Canceled</b>	Separation of the sample canceled.
	<b>Failed</b>	Sample processing failed.

**Table 8.3:** Coding of the sample positions.

### 8.4 Coding of the reagent positions







The color of the reagent positions indicates if they are occupied or empty (**Table 8.4**).

Color	Status
Light grey	Position is empty or a reagent is placed but not used for autolabeling.
Green	Reagent position is occupied for autolabeling.

**Table 8.4:** Color-coding of the reagent positions.

### 8.5 Coding of the Experiment list





The **Experiment list** is color-coded and symbol-coded to indicate the status (**Table 8.5**).

	<b>In preparation</b>	Experiment is in preparation.
	<b>Ready for processing</b>	Experiment is ready to be processed.
	<b>Processing</b>	Experiment is being processed.
	<b>Finished</b>	Experiment has been successfully finished.
	<b>Canceled</b>	Experiment has been canceled by the user.
	<b>Failed</b>	Experiment failed. If processing of one sample failed, the whole experiment is marked as failed.

**Table 8.5:** Coding of the **Experiment list**.

## 8.6 Coding of the Device check

The **Device check** is color-coded and symbol-coded to indicate the test status of each selected hardware component (**Table 8.6**).

	<b>Pending</b>	Component is waiting to be checked.
	<b>Processing</b>	Check is running.
	<b>Finished</b>	Check has been successfully finished. Hardware component works properly.
	<b>Canceled</b>	Check has been canceled by the user or the user did not respond to a check that requires user input.
	<b>Failed</b>	Check failed. Hardware error.

**Table 8.6:** Coding of the **Device check**.

## 8.7 Messages

Status messages or error messages are shown in a message box on the right side of the screen (**Figure 8.1**). In some cases you have to answer the message dialog before proceeding. If not, you can hide the message box by tapping the colored flag on the upper left side of the message box.

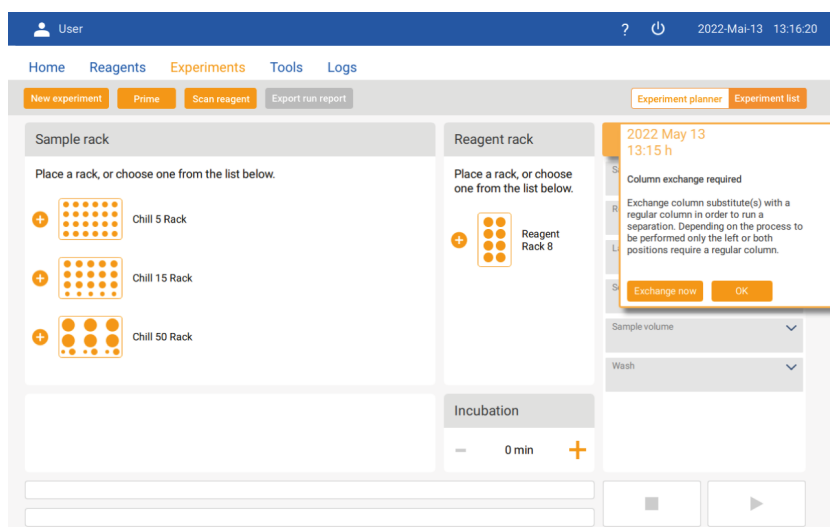

**Figure 8.1:** Message box at the right side of the screen (example warning message).

The color of the message box indicates the severity level of the issue. The following table shows the color-coding of the message box.

Color	Action
Blue	Notification.
Orange	Warning.
Red	Error. Instrument status requires user action, see chapter <b>Issues indicated by an error message on page 118</b> .

**Table 8.7:** Color-coding of the message box.

## 8.8 Instrument status

The **Overview** pane in the **Home** tab shows the current instrument status (**Figure 8.2**).

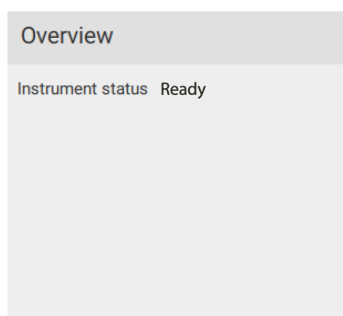

**Figure 8.2:** Overview in the Home tab.

The following table shows a selection of typical instrument status.

Status	Description
Ready	Instrument is ready for separation.
Prime required	Instrument must be primed.
Rack calibration required	Run a rack calibration, for example if the instrument has been moved.
Tube volume calibration required	Run a volume calibration, for example if a valve has been exchanged.
Running separation	Instrument is running a separation.

**Table 8.8:** Typical instrument status shown in the **Overview** pane.

## 8.9 Liquid status

You can check the liquid levels in the **Liquid** pane in the **Home** tab (**Figure 8.3**). The **Liquid** pane shows the filling level of the fluid bottles in percent.

Additionally the liquid status is checked by the instrument whenever a process or experiment is started. If the liquid level is too low, a message is displayed. The message has to be confirmed to proceed.

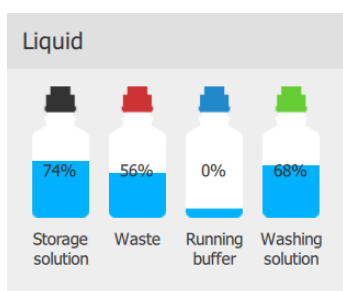

**Figure 8.3:** Liquid pane in the Home tab.



## 8.10 Column status

autoMACS Columns can be used for a maximum of 14 days or 100 separations. If columns are expired, the instrument will prompt you to exchange the expired columns when logging in. Additionally a warning sign will be displayed in the column symbol.

You can check the column status in the **Columns** pane in the **Home** tab (**Figure 8.4**). The **Columns** pane shows the following information:

- the types of columns that are currently installed
- how many days the columns have been installed for
- the number of separations done with each column

The **Columns** pane also enables column exchange. The **Exchange now** button in the upper right corner leads directly to the column exchange. For more information on the exchange of the autoMACS Columns, see chapter **Exchanging columns on page 101**.

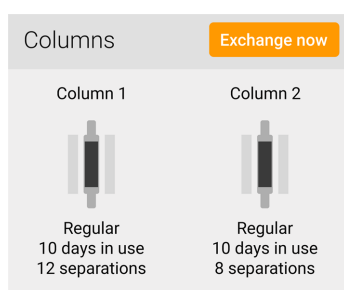

**Figure 8.4:** Columns pane in the **Home** tab.



# 9

## User management

### 9.1 User management

Only administrators have access to the **User management**.

A service user account is created by default.

#### 9.1.1 Viewing user accounts

- 1 To view existing user accounts, go to **Settings > User management**. By default, you are directed to the **Users** tab.

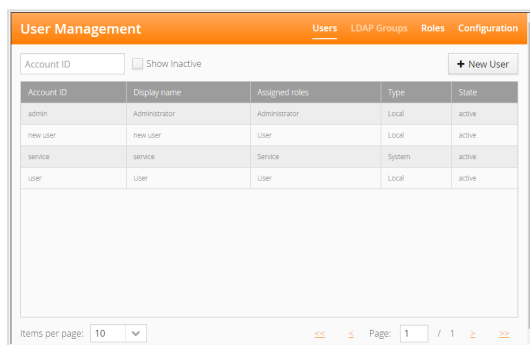

The screenshot shows the 'User Management' interface with the 'Users' tab selected. It features a search bar for 'Account ID', a 'Show Inactive' checkbox, and a '+ New User' button. Below is a table with columns for Account ID, Display name, Assigned roles, Type, and State. The table lists four users: 'admin' (Administrator, Local, active), 'new user' (User, Local, active), 'service' (Service, System, active), and 'user' (User, Local, active). At the bottom, there is a pagination control showing 'Page: 1 / 1' and 'Items per page: 10'.

Account ID	Display name	Assigned roles	Type	State
admin	Administrator	Administrator	Local	active
new user	new user	User	Local	active
service	service	Service	System	active
user	User	User	Local	active

- 2 **Account ID**, **Display name**, **Assigned roles**, **Type** (system or local), and the **State** of the user accounts are shown. The **State** of a user can be **active/inactive** or **locked**.
- 3 Optional: By default, only active user accounts are listed. Check the box **Show Inactive** to only display deactivated users.

#### 9.1.2 Password configuration

Password requirements can be set in the user management. The following options can be set:

- whether a password is generally required for all accounts
- whether the password must contain a special character, at least one number, at least one lower case character, and at least one upper case character
- the minimum password length
- the interval of password change in days
- the number of recently used passwords that cannot be used in case of a password change
- the allowed number of incorrect login attempts until the account is locked

Only administrators can set the password requirements for local users.

Configure your password settings as follows:

- 1 Go to **Settings > User management**.
- 2 Tap **Configuration**. The tab **Password Policy** opens by default.
- 3 **Password Policies:** If the checkbox **Password required** is checked, every local user account requires a password. If the checkbox is not checked, a password can be set for individual user accounts optionally.

The screenshot shows the 'Password Policy' configuration screen. It has a 'Password Policy' tab and an 'Import/Export' button. The 'Password required' checkbox is unchecked. Under 'Required characters', three checkboxes are checked: 'At least one special character (e.g. ! " # \$ % & { } \* + , : ; < = > )', 'At least one number', 'At least one lower case character', and 'At least one upper case character'. There are four input fields: 'Minimum password length' (8), 'Interval of password change' (90), 'Last passwords that may not be used' (3), and 'Number of login attempts' (3). A 'Save' button is at the bottom left.

- 4 Determine the stringency of the password. Adjust password length, required characters, etc. as needed.
- 5 Tap **Save**.

### 9.1.3 Setting up user accounts

A service user account is created by default.

User accounts can be set up in the user management.

- 1 Go to **Settings > User management**. By default, you are directed to the **Users** tab that shows the user list.

The screenshot shows the 'Users' tab in User Management. It features a search bar for 'Account ID', a 'Show Inactive' checkbox, and a '+ New User' button. Below is a table with columns: Account ID, Display name, Assigned roles, Type, and State. The table contains four rows: 'admin' (Administrator, Local, active), 'new user' (new user, Local, active), 'service' (service, System, active), and 'user' (User, Local, active). At the bottom, there is a pagination control showing 'Items per page: 10' and 'Page: 1 / 1'.

- 2 To add a new user, tap **+ New User** in the upper right side of the screen.

The screenshot shows the 'New User' creation screen. It has an 'Account ID \*' field at the top. Below are three tabs: 'Role', 'Authentication', and 'Local User Details'. The 'Role' tab is active, showing 'Available Roles' (Administrator, User) and 'Assigned Roles' (empty). Navigation arrows are between the lists. 'Save' and 'Cancel' buttons are at the bottom.

- 3 Enter a user name in the field **Account ID**.

- Assign user roles with the right arrow button as described in chapter **Assigning roles to a user account on page 87**.

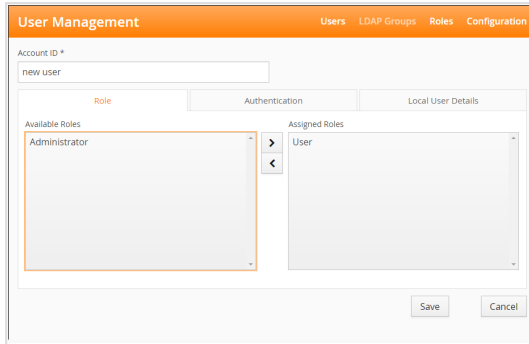

- Go to the **Authentication** tab to proceed.

Depending on the chosen password configuration, the fields under the **Authentication** tab need to be filled out accordingly, see chapter **Password configuration on page 81**.

- If a password is required by default, the left screenshot is displayed. If no password is required by default, a password can be set for individual users if desired (right screenshot). Check the box **Use password for login** to set a password, see chapter **Password configuration on page 81**.

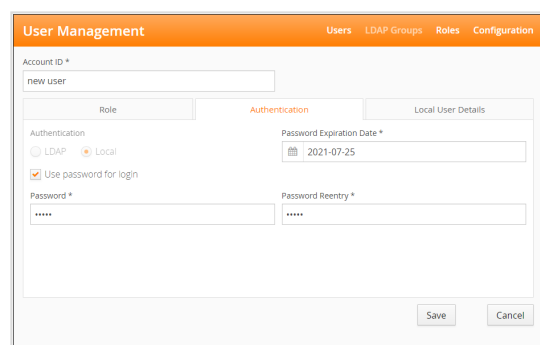
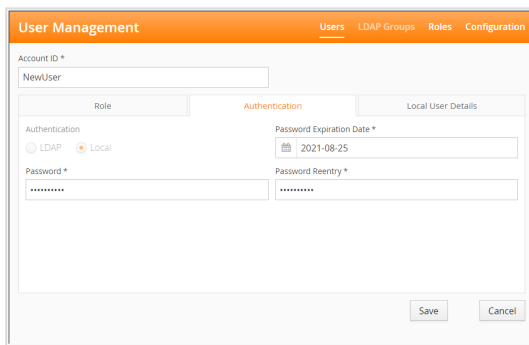

- By default, the password expiration date is automatically generated (current date plus number of days as defined during password configuration). Modify if needed, see chapter **Password configuration on page 81**.

- If applicable, enter a password. If a password does not meet the requirements, an error message appears.

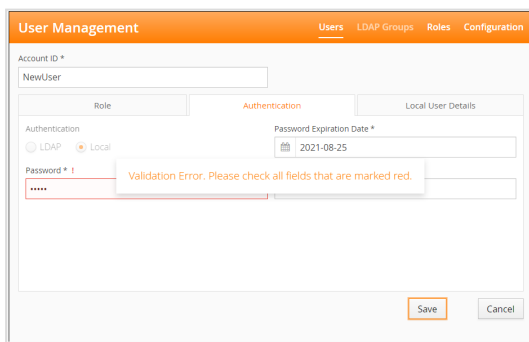

- Re-enter the password.

- Tap **Save**.

- Go to the **Local User Details** tab to proceed. Fields marked with a red asterisk are mandatory. All other fields are optional.

- Enter the user name to be shown in the title bar in the field **Display name** and the user initials in the field **Initials**. If desired, enter first name, last name, e-mail address, and further description of the user.

- Tap **Save**. The new user is now visible in the user list.

Account ID	Display name	Assigned roles	Type	State
admin	Administrator	Administrator	Local	active
new user	new user	User	Local	active
service	service	Service	System	active
user	User	User	Local	active

## 9.1.4 Deactivating user accounts

User accounts that were set up locally on the instrument cannot be deleted. They can only be deactivated. This prevents a newly set up user account from having the same parameters (name, ID, ...) as a previously deleted account.

- Go to **Settings > User management**. By default, you are directed to the **Users** tab.
- The user list is shown. Tap the user that is to be inactivated.

- Tap the **Set inactive** button.

## 9.1.5 Unlocking user accounts

User accounts will be locked if a user attempts to log in with wrong login credentials. The number of attempts can be set during password configuration, see chapter **Password configuration on page 81**.

Only an administrator can unlock user accounts.

- To unlock, go to **Settings > User management**. By default, you are directed to the **Users** tab.
- Tap the locked user account.

- 3 Tap the **Unlock** button.

## 9.1.6 Pre-configured user roles

The roles **User** and **Administrator** are pre-configured and cannot be modified. The roles **User** and **Administrator** can be assigned to user accounts. Additionally custom user roles can be set up in the user management, see chapter **Creating new user roles below**.

Only roles with administrator rights have access to the user management and instrument settings.

The following **Table 9.1** shows the different rights between user and administrator roles.

Right	Description	Pre-configured roles	
		Administrator	User
Administrator access	Access to administrative features, such as instrument settings and user management	Yes	No
User access	Access to user functions, such as experiment definition and task planner.	Yes	Yes

**Table 9.1:** Access rights of the pre-configured roles **Administrator** and **User**.

## 9.1.7 Creating new user roles

- 1 Go to **Settings > User management**.
- 2 Go to the **Roles** tab. A list with existing user roles is shown.

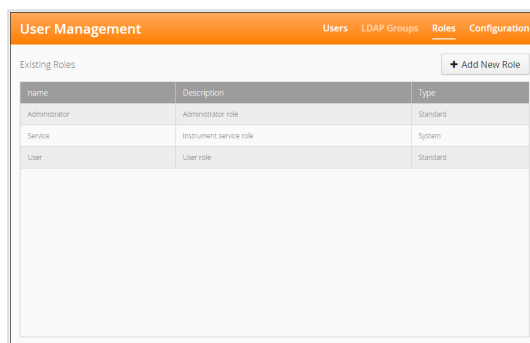

- 3 To add a new role, tap the **+ Add New Role** button.
- 4 Enter a role name and description.

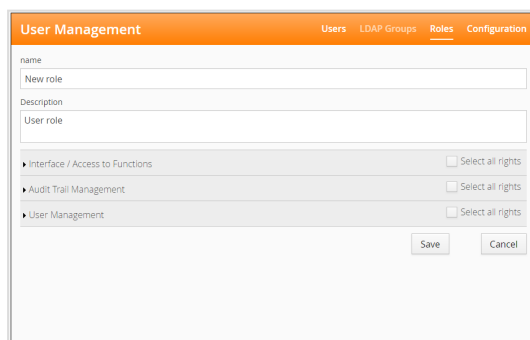

5 To view and modify rights, tap the arrows.

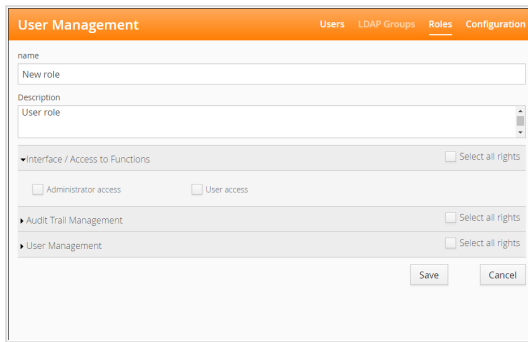

6 Assign rights as needed (Table 9.2). Note that **Audit Trail Management** is not yet available.

7 Tap **Save**. The new role is now visible in the list.

Right	Description
Read details of other users' accounts	Allows the user to view account details such as user name and full name for an account other than the own, in order to be able to administer the account.
Read details of own account	Allows the user to view account details such as user name and full name for own account, e.g. in order to be able to authenticate credentials of own account.
Update details of own account	Allows the user to update account details such as user name and full name for own account, e.g. in order to be able to modify credentials of own account.
Update details of other users' accounts	Allows the user to view account details such as user name and full name for an account other than the own, in order to be able to administer the account.
Read rights of other users' accounts	Allows the user to view rights assigned to an account other than the own, in order to administer the account.
Read rights of own account	Allows the user to view rights assigned to own account.
Create user	Allows the user to set up user accounts.
Set user active/inactive	Allows the user to set user accounts to active or inactive.
Unlock user	Allows the user to unlock user accounts.
Create role	Allows the user to create new roles, that can be assigned to accounts.
Read role	Allows the user to read details of existing roles.
Update role	Allows the user to modify rights assignment to existing roles.
Assign role	Allows the user to assign roles to accounts.
Update password policy	Allows the user to change password settings.
Reads password policy	Allows the user to read password settings.

**Table 9.2:** Possible user management rights of the **Administrator** role.



## 9.1.8 Modifying user roles

Only an administrator can modify user roles. User roles that are pre-defined in the system cannot be modified.

- 1 Go to **Settings > User management**.
- 2 Go to the **Roles** tab. A list with existing user roles is shown.

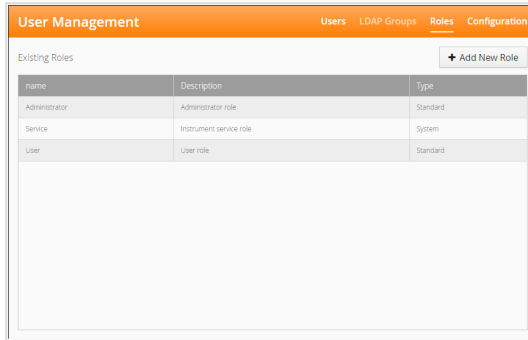

- 3 Tap the role to be modified. Adjust as needed.

## 9.1.9 Assigning roles to a user account

The user management can be accessed by a user with administrator rights. Administrators have both the **User** and **Administrator** role assigned.

- 1 Go to **Settings > User management**.
- 2 Go to the **Users** tab. Tap the user name.

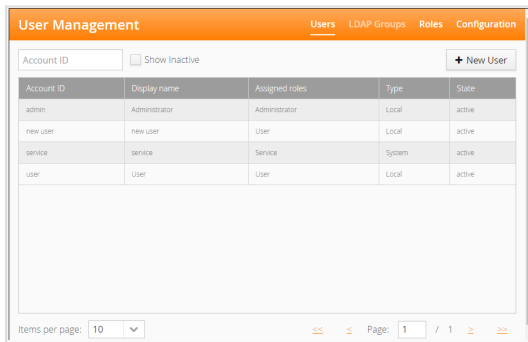

- 3 Within the left panel **Available Roles**, select the desired role.

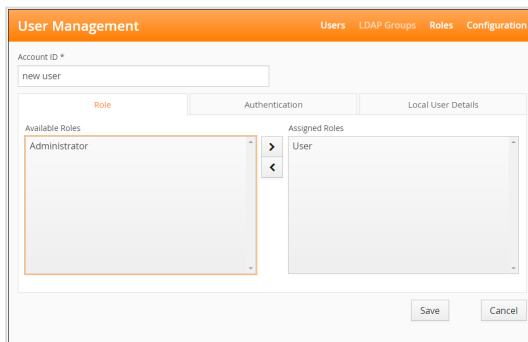

- 4 Tap the right arrow button to move the selected role(s) to the panel **Assigned Roles**.
- 5 Tap **Save**.

## 9.1.10 Changing role assignment

- 1 Go to **Settings > User management**.
- 2 Go to the **Users** tab. A list of all assigned users is shown.

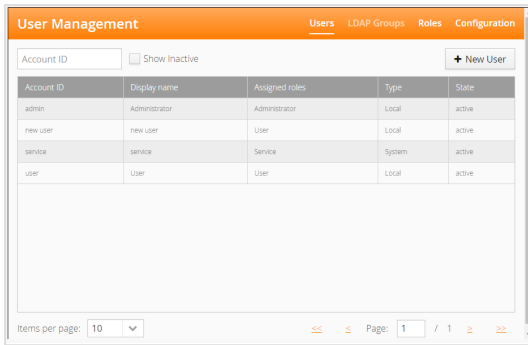

- 3 Within the displayed list of users, select the user whose role you want to modify.

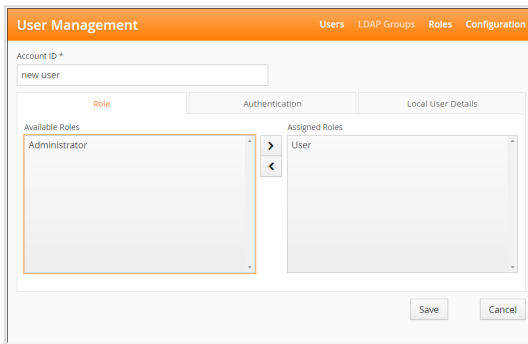

- 4 To add a role, select the desired role from the left panel **Available Roles**. Selected roles are highlighted in blue.
- 5 Tap the right arrow button to move the selected role(s) to the panel **Assigned Roles**.
- 6 To remove a role, select the desired role from the right panel **Assigned Roles**. Selected roles are highlighted in blue.
- 7 Tap the left arrow button to move the selected role(s) to the panel **Available Roles**.
- 8 Tap **Save**.

## 9.2 Changing passwords

This function is accessible to all users.

- 1 Tap the user **User** symbol in the title bar. The **User** menu opens.
- 2 Tap **Change password**. A dialog box opens.

The screenshot shows a 'Change password' dialog box. It has a title bar with the text 'Change password'. Below the title bar, there are four input fields: 'Username' (with the value 'User'), 'Current password', 'New password', and 'Confirm new password'. At the bottom, there are two buttons: 'Cancel' and 'Change password'.

- 3 Enter your current password and the new password. Re-enter the new password.
- 4 Tap **Change Password** to save.

# 10

## Cleaning and disinfection

### **WARNING**

**Electric devices bear the risk of electric shock, short circuits, overheating, fire, and explosion. This may lead to burns, severe personal injury, or death.**

- Do not remove or penetrate any cover of the housing except for the front access covers.
- Only service personnel is allowed to remove any other cover of the instrument.

### **WARNING**

**Biohazardous material.**

**Contamination or infection may lead to severe personal injury or death, depending on the material used.**

- Run the **Clean** program first before maintenance work on any part of the fluidic system.
- Wear personal protective equipment (such as gloves, safety glasses, etc.) as indicated in the safety data sheet for the particular substance.

### 10.1 Washing and maintenance programs

The autoMACS NEO Separator uses reusable autoMACS Columns. After each cell separation, a washing program rinses the columns of the autoMACS NEO Separator. When the washing program is completed, columns and tubing system are filled with autoMACS Running Buffer – MACS Separation Buffer. There are daily washing programs which have to be performed, for example, after a separation. There are also maintenance and other programs which are to be used periodically for special applications.

All washing and maintenance programs can be started manually from the **Tools** tab. Note the liquid consumption of each program shown in the following table.

Program	Time	autoMACS Running Buffer – MACS Separation Buffer	autoMACS Washing Solution	Storage solution	Bleach solution
QRinse	2 min	56 mL	2 mL	–	–
Rinse	6 min	70 mL	119 mL	–	–
Clean	8.5 min	76 mL	119 mL	58 mL	–
Sleep	7 min	–	119 mL	70 mL	–
Store	9 min	–	119 mL	135 mL	–
Prime	4 min	112 mL	3 mL	2 mL	–
Bleach	19 min	58	114 mL	7 mL	40 mL
Column exchange	3.5 min	98 mL	–	–	–
Rescue	2 min	65 mL	–	–	–

**Table 10.1:** Liquid consumption of different programs.

### 10.1.1 Rinse

**Rinse** is an extensive washing program that uses autoMACS Washing Solution and autoMACS Running Buffer – MACS Separation Buffer. Use the **Rinse** program between separations of rare cells, e.g., stem cells.

### 10.1.2 QRinse

**QRinse** is a standard short washing program that uses autoMACS Running Buffer – MACS Separation Buffer and autoMACS Washing Solution. Use the **QRinse** program between separations of cells with normal frequency.

### 10.1.3 Clean

**Clean** is an optional, very extensive washing program. It uses storage solution, autoMACS Washing Solution, and autoMACS Running Buffer – MACS Separation Buffer. Use the **Clean** program after separation of whole blood or bone marrow samples.

### 10.1.4 Sleep

After a separation or if the fluidic system is filled with buffer, run the **Sleep** program before overnight storage. When the program has been finished, the fluidic system is filled with storage solution (contains 70% ethanol). You can select **Sleep** instead of a washing program after your last separation. Alternatively, schedule a daily task for **Sleep** in the **Task planner**, see chapter **Creating tasks on page 35**.

- 1 Go to **Tools > Programs**.
- 2 Select **Sleep**.
- 3 Tap the **Run** button and wait until the program has finished successfully. After running the **Sleep** program, the fluid bottles are blinking green.
- 4 Switch the instrument into standby mode, see chapter **Switching into standby on page 29**.
- 5 Wipe the needles with a tissue soaked with distilled or deionized water to prevent the formation of salt deposits.

### 10.1.5 Store

Run the **Store** program for long term storage if the autoMACS NEO Separator will not be used for more than two weeks. The **Store** program automatically performs a cleaning procedure. After the **Store** program, the fluidic system is filled with storage solution (contains 70% ethanol). Before running the **Store** program column substitutes must be installed.

- 1 Install column substitutes, see chapter **Exchanging columns on page 101**.
- 2 Go to **Tools > Programs**.
- 3 Select **Store**.
- 4 Tap the **Run** button. After running the **Store** program, the fluid bottles are blinking green.
- 5 Shut down the instrument, see chapter **Shutting down on page 29**.
- 6 Wipe the needles with a tissue soaked with distilled or deionized water to prevent the formation of salt deposits.

## 10.2 Surface disinfection

The rear needle of the robotic needle arm and the surface of the instrument must be decontaminated upon contact with biohazardous samples.

**WARNING! Liquids inside the instrument can cause short circuits. Unplug the instrument before cleaning it. Use only small amounts of cleaning agents on a soft cloth to wipe the instrument. Do not spray or pour liquid cleaning agents onto or into the instrument.**

- 1 Wipe the instrument surface and the rear needle with a soft cloth.
- 2 Use disinfectants for decontamination that are in accordance with any local regulations. The housing material and the needles are resistant against disinfectants that contain alcohol, 1% sodium hypochlorite, and tensides (such as storage solution or bleach solution).

## 10.3 Disinfection of the fluidic system

Depending on the level of use and general instrument maintenance, it is recommended to run the **Bleach** program every 3 to 6 months. If predominantly whole blood, bone marrow, or tissue samples are separated, the **Bleach** program should be performed once a month. As the **Bleach** program requires a column exchange, the periodic column exchange can be replaced by running the **Bleach** program.

The **Bleach** program is a disinfectant procedure for cleaning of the fluidic system. A bleach solution is recommended for the **Bleach** program. For preparation of the bleach solution, see chapter **Preparing liquids on page 25**.

Specific steps of the **Bleach** program require different procedures, depending on whether autoMACS Columns or column substitutes are installed.

- 1 Go to **Tools > Programs** and select **Bleach**.
- 2 Tap **Next**. Read the instructions on the display.
- 3 Disconnect the tubings from the bottle closures of the autoMACS Running Buffer – MACS Separation Buffer and the autoMACS Washing Solution.
- 4 Place the ends of the tubings in a minimum of 15 mL of bleach solution.
- 5 Tap **Next** to start the program.
- 6 Fill a sample tube with 25 mL of bleach solution and place it in position A1 of a Chill 50 Rack.

- 7 Tap **Next** to start the bleach process. The tubing system will be flushed with the bleach solution and incubated.
- 8 Optional: Remove the bottle closures of the autoMACS Running Buffer – MACS Separation Buffer bottle and the autoMACS Washing Solution bottle. Remove the hydrophobic air filters and wash the bottle closures and cannulae with detergent, bleach solution, or storage solution. Rinse thoroughly with deionized water. Reconnect the hydrophobic air filters. Then reconnect the bottle closures.
- 9 Tap **Next**.
- 10 Take the tubings out of the bleach solution and thoroughly dry them with clean tissues. Reconnect them to the respective bottle closures. Tap **Next**.
- 11 Manually clean the needles with storage solution.
- 12 Tap **Next** to continue. The instrument will prepare the columns for exchange.
- 13 Wait until the rinsing process has been finished. When the process is successfully completed, instructions on how to replace the columns are shown on the display. Proceed depending on whether autoMACS Columns or column substitutes are installed, see chapter **Replacing the columns when the Bleach program is successfully completed below**.

### 10.3.1 Replacing the columns when the Bleach program is successfully completed

Depending on what the column slots were equipped with during the **Bleach** program, there are the following options:

#### **During the Bleach program, two column substitutes were installed.**

There are two options:

The two column substitutes are to stay installed.

- 1 Select **Column substitutes** in the display menu.
- 2 Tap **Next**.
- 3 Follow the menu instructions.

One or both of the column substitutes are to be replaced by an autoMACS Column.

- 1 Select **autoMACS Column** for one or both column slots in the display menu.
- 2 Tap **Next**.
- 3 Continue with step 9 of the column exchange, see chapter **Exchanging columns on page 101**.

#### **During the Bleach program, one or two autoMACS Columns were installed.**

One or both autoMACS Columns have to be replaced by a new autoMACS Column or a column substitute.

- 1 In the display menu select autoMACS Column or column substitutes for one or both column slots.
- 2 Tap **Next**.
- 3 Continue with step 9 of the column exchange, see chapter **Exchanging columns on page 101**.

## 10.4 Cleaning the needles

It is recommended to clean the front and rear needle every 14 days. Clean the needles before running the **Sleep** program for overnight storage.

- 1 Run the **Clean** program.
- 2 When **Clean** has been finished, shut down the instrument.
- 3 Switch off and unplug the instrument.
- 4 Remove all racks from the MACS MiniSampler S.
- 5 Ensure that the needle arm is in the uppermost position and that the tubes are not bent.
- 6 Clean the needles one after another. Take the rear needle at the top and pull it out of the holder.
- 7 Take the front needle at the holder and slide it up along the guiding.

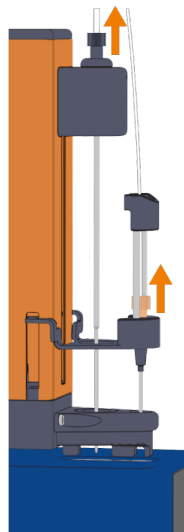

- 8 Wipe the needles and the needle ports with tissue soaked with disinfectant followed by distilled or deionized water. Disinfectants used for decontamination must be in accordance with any local regulations. The needles are resistant against disinfectants that contain alcohol, 1% sodium hypochlorite, and tensides (such as storage solution or bleach solution).
- 9 Unscrew the rear needle from the tubing and soak it in distilled or deionized water to remove salt residues from the needle.
- 10 Reinstall the needles.
- 11 Plug in and switch on the instrument.
- 12 Run the **Prime** program.
- 13 Turn the instrument into standby mode or schedule a **Sleep** task.

## 10.5 Cleaning the washing station

The washing station is designed for automated rinsing of the front and rear needle as well as for surface cleaning of the front and rear needle. The washing station should be cleaned as needed to remove spills and salt deposits.

- 1 Run the **Clean** program.
- 2 When **Clean** has been finished, shut down the instrument.
- 3 Switch off and unplug the instrument.
- 4 Make sure that the needle arm is in the uppermost position.

- 5 Open the front cover and lift it for removal.
- 6 Open the cover of the washing station and remove it.
- 7 Remove the MACS MiniSampler S and the bottom cover.

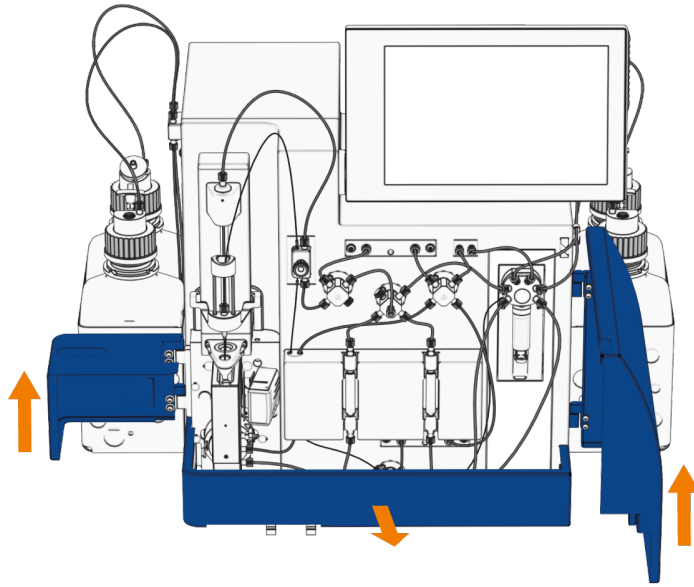

- 8 Unscrew the knurled screw at the rear side of the washing station. The screw attaches the washing station to the instrument.

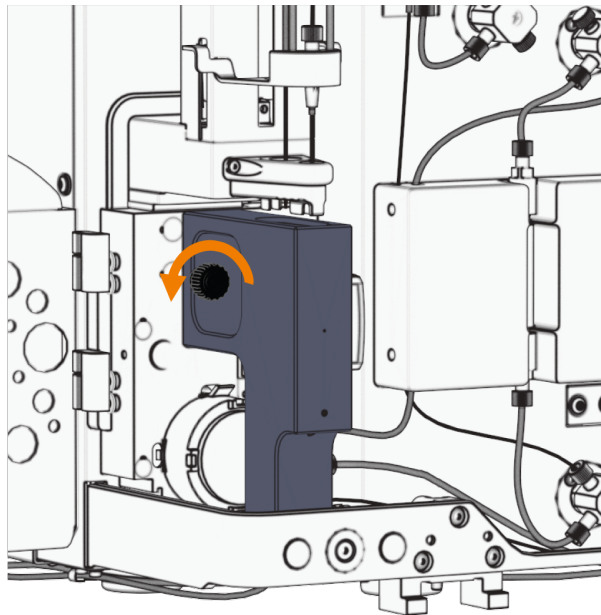



- 9 Pull the washing station forwards and tilt it to the left.

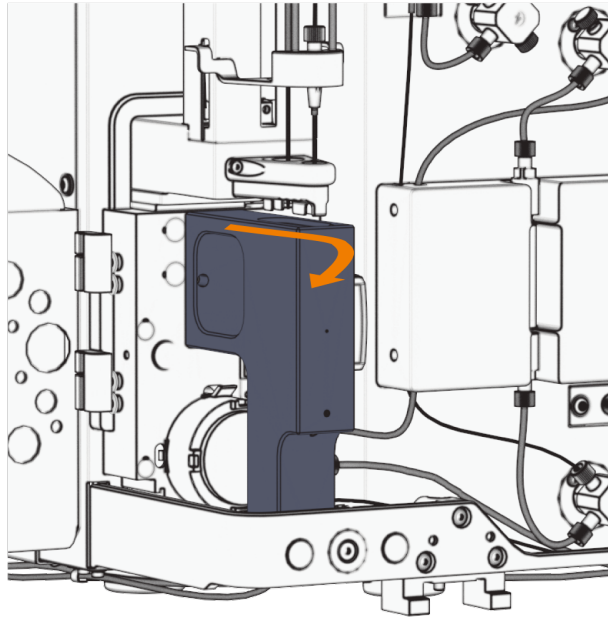

It is recommended to label the tubing connectors to ensure the right assignment when reassembling.

- 10 Disconnect the tubing to the waste pump. Press the tubing clamps and pull to remove the tubing. Pull strictly sideways to avoid breaking the connector.

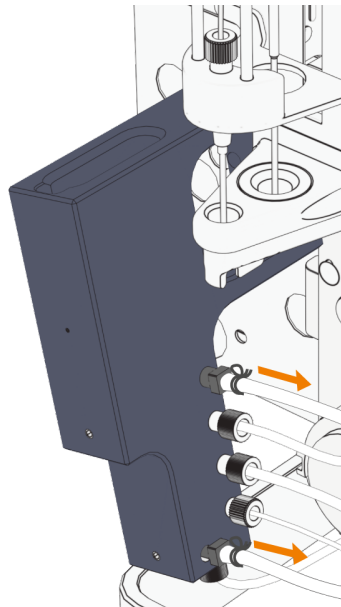

- 11 Unscrew the three tubing connectors at the right-hand side of the washing station.

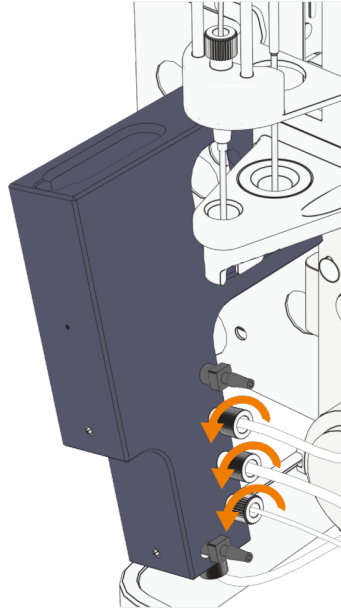

- 12 Unscrew the tubing to the waste bottle at the bottom of the washing station. Place a cloth underneath to absorb any liquid that may leak out.

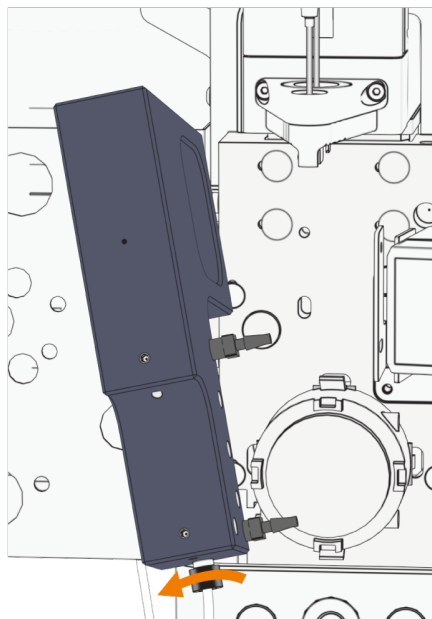

**NOTICE: Neither autoclave the washing station nor wash it in a dishwasher.**

- 13 Soak the washing station in distilled water for 15 min. If working with infectious material or blood, additionally soak the washing station in bleach solution or storage solution for 15 min.
- 14 Reassemble the unit in reverse order.
- 15 Reinstall all covers and the MACS MiniSampler S. Close the covers.
- 16 Plug in and switch on the instrument.
- 17 Run the **Prime** program.
- 18 Run the **Clean** program.
- 19 Run a **Rack calibration**, see chapter **Rack calibration on page 31**.

## 10.6 Cleaning the diluter valve

Use this cleaning program to rinse the diluter valve. The bypass tubing between the diluter valve and the washing station is also cleaned.

- 1 Go to **Tools > Programs** and select **Clean diluter valve**.
- 2 Tap **Start** to run the program.



# 11

## Maintenance

### **WARNING**

**Electric devices bear the risk of electric shock, short circuits, overheating, fire, and explosion. This may lead to burns, severe personal injury, or death.**

- Do not remove or penetrate any cover of the housing except for the front access covers.
- Only service personnel is allowed to remove any other cover of the instrument.

### **WARNING**

**Biohazardous material.**

**Contamination or infection may lead to severe personal injury or death, depending on the material used.**

- Run the **Clean** program first before maintenance work on any part of the fluidic system.
- Wear personal protective equipment (such as gloves, safety glasses, etc.) as indicated in the safety data sheet for the particular substance.

Instrument parts wear over time, especially tubing and valves. Depending on the sample material and frequency of use, these parts require regular maintenance and/or replacement. Contact Miltenyi Biotec Technical Support regarding spare parts. Miltenyi Biotec also offers service contracts for the autoMACS NEO Separator. Visit [www.miltenyibiotec.com](http://www.miltenyibiotec.com) for further information.

### 11.1 Exchanging empty bottles

To avoid contamination and spillover, do not open a full bottle before it is placed in its holder. Change one fluid bottle at a time.

- 1 Take out the empty bottle and unscrew the bottle closure counter-clockwise but do not remove the bottle closure from the bottle. Do not disconnect the color-coded tubing.
- 2 Place a full bottle into its appropriate holder, open it and fasten the bottle closure to the new bottle. Avoid any contact of the hydrophobic air filter with fluids as this may cause clogging of the filter.

## 11.2 Emptying the waste bottle

### **WARNING**

**Biohazardous waste.**

**Contamination or infection may lead to severe personal injury or death, depending on the material used.**

- Immediately replace the waste bottle after unmounting and fasten the bottle closure to the new bottle.
- Prefill the empty waste bottle with an appropriate disinfectant according to the specification of the manufacturer.
- Always have an empty waste bottle available.

Before removing a full waste bottle from the bottle holder, fasten a screw cap onto the bottle to avoid spillover.

- 1 Unscrew the bottle closure counter-clockwise but do not remove the bottle closure from the bottle. Do not disconnect the color-coded tubing. Avoid any contact of the hydrophobic air filter with fluids as this may cause clogging of the filter.
- 2 Place an empty waste bottle next to the bottle holder and label the new waste bottle with the biohazard stickers included in the delivery.
- 3 Fasten the bottle closure to the new bottle.
- 4 Close the full waste bottle with a screw cap and remove it from the bottle holder.
- 5 Place the empty bottle in the bottle holder.
- 6 Continue with the separation.

## 11.3 Exchanging hydrophobic air filters

### **WARNING**

**Defective or inadequate equipment can cause a biological hazard.**

**Contamination or infection may lead to severe personal injury or death, depending on the material used.**

- Exchange hydrophobic air filters once a year to avoid clogging through dust deposits.
- Exchange hydrophobic air filters, if they came into direct contact with any liquid to avoid clogging of the filters and to prevent contamination of liquids.

The hydrophobic air filters (0.2 µm) are attached to the bottle closures to vent the fluid bottles and to prevent release of aerosols.

Contact Miltenyi Biotec Technical Support for specification and replacement of the filters.

Make sure to use hydrophobic filters.

## 11.4 Exchanging columns

### **WARNING**

**The instrument has a powerful magnet.**

**Magnetizable objects can suddenly move towards the magnet.**

- Keep all magnetic storage devices, electronic equipment, and magnetizable objects at a distance of at least 30 cm from the instrument.

### **WARNING**

**The instrument has a powerful magnet.**

**Strong magnetic fields can influence the functioning of pacemakers or electronic medical implants.**



If wearing pacemakers or electronic medical implants keep a distance of at least 30 cm from the instrument.

Exchange autoMACS Columns at least every 14 days or after 100 separations. Column exchange must be completed once the exchange program is running.

- 1 Run the **Clean** program.
- 2 Remove all racks from the MACS MiniSampler S.
- 3 Open the front cover of the autoMACS NEO Separator.
- 4 Go to the **Home** tab and tap the **Exchange now** button in the **Columns** pane. Alternatively, go to **Tools > Column exchange**. The **Column exchange** program opens.
- 5 Select one or both columns to be exchanged.
- 6 Tap **Next**. The instrument prepares the columns for exchange. Wait until the preparation is complete.
- 7 Tap **Next**. Select the new column type(s) to be installed in place of the columns that have been discarded: **Regular** or **Substitute**.
- 8 Tap **Next** to continue. Read the instructions on the screen on how to replace the columns.
- 9 Using both hands, take the top and bottom of the column and pull gently to remove it from its slot in the magnet.
- 10 Hold the column in one hand and unscrew the bottom column connector clockwise and the top column connector counter-clockwise (**Figure 4.1**).
- 11 Insert a random end of a fresh column into the bottom column connector and screw in the column by turning it clockwise until you feel resistance.
- 12 Point the column towards the top of the instrument and screw in the top connector.
- 13 Align the column with the top connector sitting on the guiding of the magnet cover.
- 14 Press the column into the slot until you feel the guides click.
- 15 Verify that the column is placed in the center of the magnet cover.
- 16 Repeat steps 9 to 15 with the second column, if necessary.
- 17 Ensure that the tubing is neither pinched nor obstructed.
- 18 Tap **Next** to finish the column exchange. The instrument will run a **Prime** to fill the new columns with buffer and the instrument status will change to **Ready**.
- 19 Check that the columns are securely fastened to the column connectors and that no buffer is leaking.
- 20 Close the front cover.

## 11.5 Maintaining the syringe (administrators only)

### CAUTION

#### **Moving syringe pump.**

#### **Risk of crushing or cutting.**

- Keep away from the syringe pump while the instrument is in operation.
- Do not obstruct the movement of the syringe pump.

You can use the **Exchange syringe** program to replace the syringe by a new one or to clean and reinstall the syringe.

Depending on the level of usage, the syringe has to be cleaned every 1–3 months. Appropriate maintenance and long-term storage assures that no salt deposits accumulate in the syringe. Salt deposits may cause wear of the pump seal and thus may lead to leakage. The syringe should not run dry at any time. This can damage the pump seal and thereby may lead to leakage.

- 1 Run the **Clean** program.
- 2 When **Clean** has been finished, go to **Tools > Diluter Unit** and select **Exchange syringe**.
- 3 Tap **Start**.
- 4 Open the front cover.
- 5 When prompted, loosen the plunger lock screw at the bottom of the plunger by turning it clockwise (**Figure 11.1**).
- 6 Tap **Next**. The plunger holder will move to the lowest position and the instrument will shut down.
- 7 Switch off and unplug the instrument.
- 8 Unscrew the syringe from the diluter valve housing by turning the knurled silver top screw clockwise. Grip the syringe at the top screw only (**Figure 11.1**). Do not compress the glass, as it might break.
- 9 If you want to clean the syringe, carefully remove the plunger from the syringe. Place a container underneath to prevent spilling. Wash with distilled or deionized water to remove salt deposits.
- 10 Gently push the plunger halfway into the cleaned or a new syringe. Make sure that the plunger lock screw is dry before proceeding with installation of the syringe.
- 11 Fasten the syringe at the diluter valve by turning the top screw counter-clockwise until a resistance is met. Unfasten again by one rotation. Grip the syringe at the top knurled screw only. Do not compress the glass, as it might break.
- 12 Pull out the plunger of the syringe until it reaches its fitting in the plunger holder. The plunger must have the same orientation as the fitting.
- 13 Tighten the syringe at the diluter valve by turning until a resistance is met. Tighten the plunger lock screw.
- 14 Close the front cover. Plug in and switch on the instrument. The syringe exchange program opens again.
- 15 Tap **Finish** to confirm the syringe exchange. The instrument automatically will run a **Prime**.
- 16 Run a **Volume calibration** to calibrate the fluidic volume control of the instrument, see chapter **Volume calibration on page 31**.



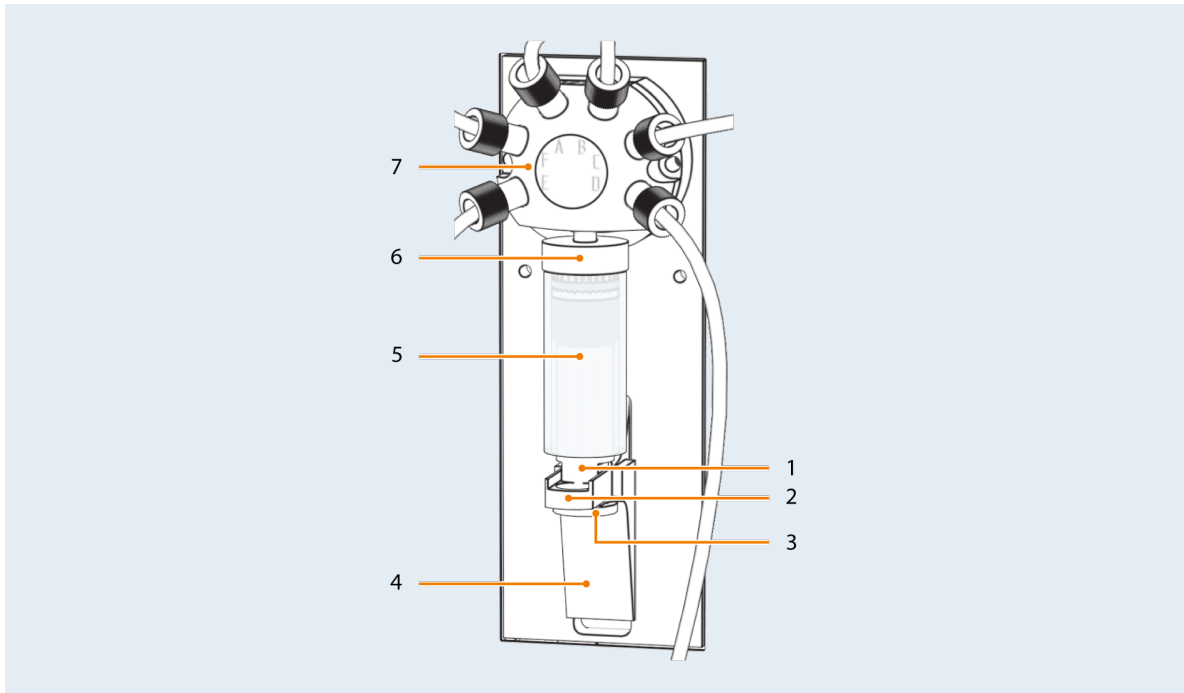

**Figure 11.1:** Diluter valve with syringe.

- |   |                    |   |               |
|---|--------------------|---|---------------|
| 1 | Plunger            | 5 | Syringe       |
| 2 | Plunger holder     | 6 | Top screw     |
| 3 | Plunger lock screw | 7 | Diluter valve |
| 4 | Finger guard       |   |               |

## 11.6 Maintaining the diluter valve (administrators only)

You can exchange the diluter valve or the diluter valve together with the syringe as follows. The diluter valve exchange requires demounting of the syringe. Contact Miltenyi Biotec Technical Support if you need assistance.

- 1 Run the **Clean** program.
- 2 Wait until **Clean** has been finished.
- 3 Go to **Tools > Diluter Unit** and select **Exchange valve** or **Exchange syringe and valve**.
- 4 Tap **Start**. All tubes mounted at the diluter valve will be filled with air to prevent dripping. Wait until the process has been completed.
- 5 Open the washing station cover and the front cover.
- 6 Loosen the plunger lock screw at the bottom of the plunger by screwing it clockwise (**Figure 11.1**).
- 7 Tap **Next**. The plunger holder will move to the lowest position and the instrument will shut down.
- 8 Switch off and unplug the instrument.
- 9 Unscrew the syringe from the diluter valve housing by turning the knurled silver top screw clockwise. Grip the syringe at the top screw only (**Figure 11.1**). Do not compress the glass as it might break.
- 10 Demount the valve. Unscrew the tubings marked with A–F from the valve.
- 11 Unscrew the two hexagonal socket screws with the delivered Allen wrench.

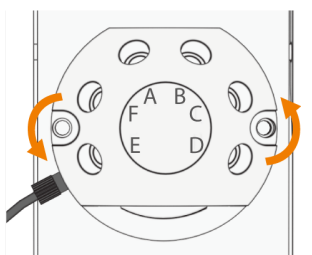

- 12 Pull out the diluter valve from the coupling and put it aside. Mind the bypass tubing to the washing station.
- 13 Insert the new valve.
- 14 Mount the hexagonal socket screws.
- 15 Reconnect the tubing according to the letters on the diluter valve and tubing.
- 16 Guide the bypass tube to the washing station behind the other tubings as shown below.

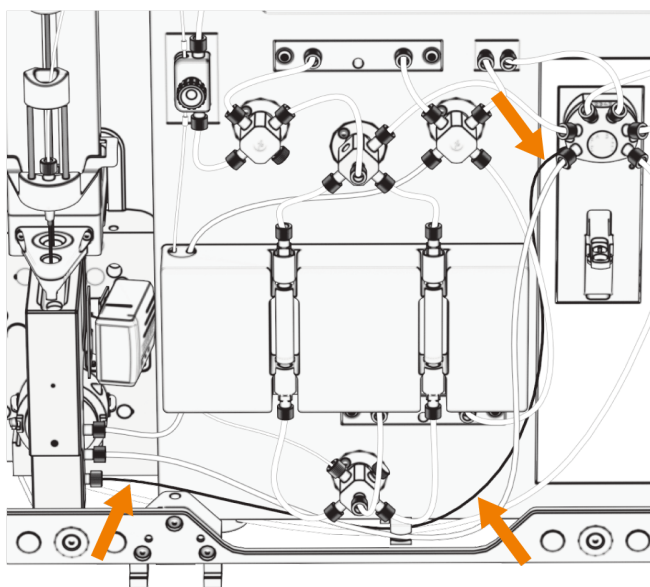

- 17 Demount the washing station as described in chapter **Cleaning the washing station on page 93**. Pull the washing station forwards and tilt it to the left.
- 18 Demount the old bypass tube.

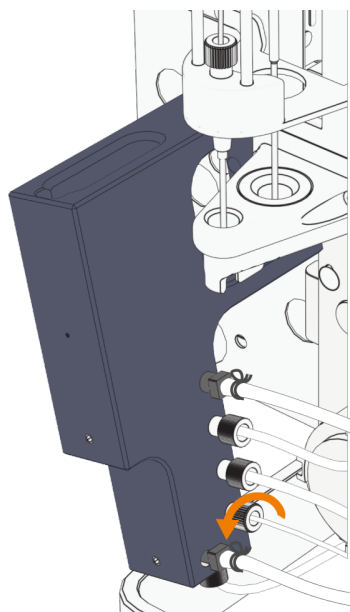

- 19 Install the new bypass tube. Tightly fasten the connector.
- 20 Reinstall the washing station.
- 21 Reinstall the syringe or install a new syringe as described in steps 10-13 of the chapter **Maintaining the syringe (administrators only)** on page 102.
- 22 Close the covers. Plug in and switch on the instrument. The selected program **Exchange valve** or **Exchange syringe and valve** opens again.
- 23 Tap **Finish** to confirm the diluter valve exchange or diluter valve and syringe exchange. The instrument will automatically refill the tubing and the syringe.
- 24 Run a **Volume calibration** to calibrate the fluidic volume control of the instrument, see chapter **Volume calibration** on page 31.
- 25 Optional: If the MACS MiniSampler S has been moved, run a **Rack calibration**. For details, see chapter **Rack calibration** on page 31.

## 11.7 Exchanging valves (administrators only)

### **CAUTION**

**Rotating valve drive.**

**Risk of trapping fingers and hair pulled in.**

- Unplug the instrument before exchanging the valves.
- Do not reach into the valve drive when the valve is disassembled.

The top valves and the bottom valve should be replaced after 2000 rotations.

- 1 Run the **Clean** program.
- 2 Wait until **Clean** has been finished.
- 3 Go to **Tools > Valve Exchange**. The following screen appears.

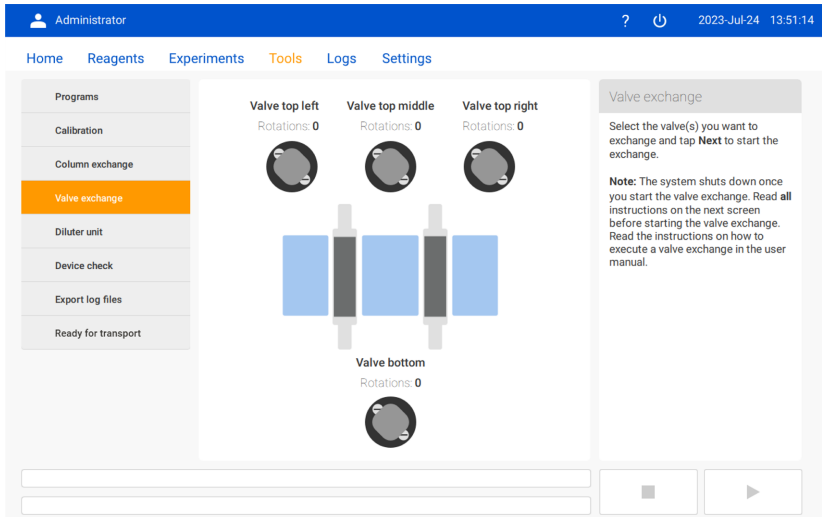

- 4 Tap the valves that have to be exchanged and tap **Next** to proceed.
- 5 Tap **Start**. The valves will be automatically turned to the exchange position. After that the instrument will shut down.
- 6 Switch off and unplug the instrument.
- 7 Open the front cover.
- 8 For exchange of the lower valve, remove the MACS MiniSampler S first. Then firmly pull to remove the bottom cover of the autoMACS NEO Separator.

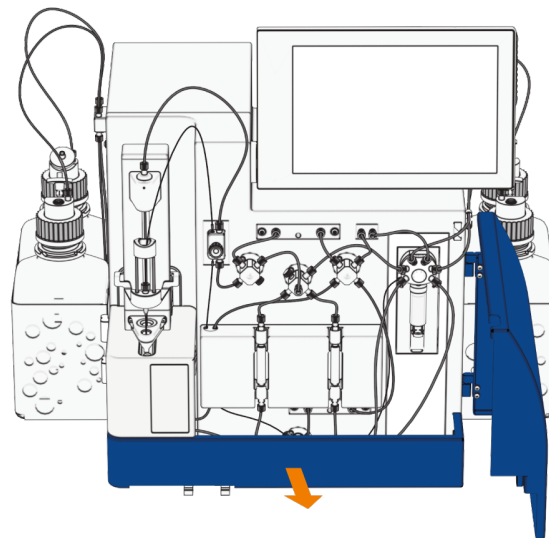

- 9 Detach all tubing and blind screws from the respective valve.

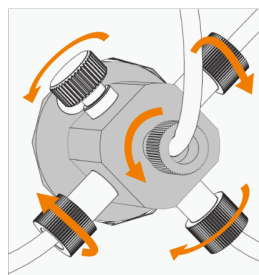

- 10 Loosen the two valve screws with the Allen wrench delivered with the autoMACS NEO Separator.

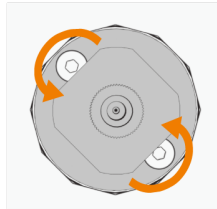

- 11 Pull out the valve.
- 12 Check if the groove in the valve drive is positioned horizontally and in the lower half of the axis.
- 13 Make sure that the bracket of the new valve is positioned horizontally as shown in **Figure 11.2**.
- 14 Carefully insert the new valve allowing the bracket to find the groove in the valve drive. At first, the bracket will slide in only halfway.
- 15 Rotate the valve gently. The two adjustment pins will slide into their corresponding holes in the valve plate.
- 16 Make sure that the valve is fully inserted into the valve drive. Fasten the valve screws with the Allen wrench.
- 17 Connect the tubing to the installed new valve and fasten the tubing hand-tight.
- 18 Reinstall the bottom cover and the MACS MiniSampler S.
- 19 Plug in and switch on the instrument. The valve exchange proceeds automatically.
- 20 Follow the instructions on the display. The system prompts you to confirm or reject the valve exchange.
- 21 The instrument automatically will run a **Prime**. If leakage occurs, contact the Miltenyi Biotec Technical Support.

Take care not to pinch the tubing at the bottom left of the instrument, when closing the bottom cover.

- 22 Close the front cover.
- 23 Run a **Volume calibration** to calibrate the fluidic volume control of the instrument, see chapter **Volume calibration on page 31**.
- 24 Optional: If the MACS MiniSampler S has been moved, run a **Rack calibration**. For details, see chapter **Rack calibration on page 31**.

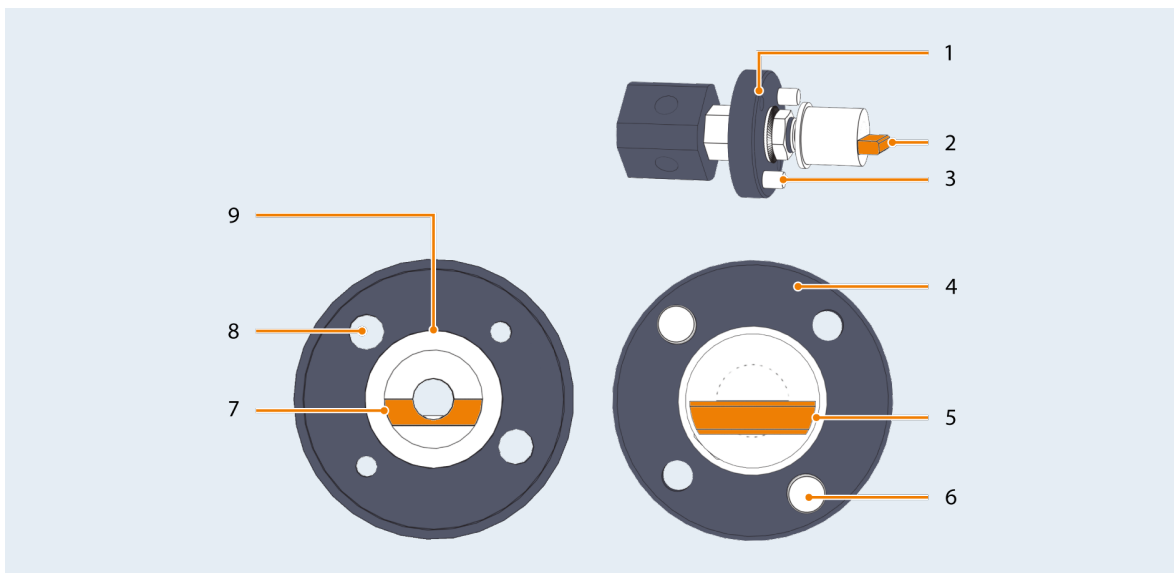

**Figure 11.2:** Valve and valve drive of the autoMACS NEO Separator (bracket and groove are highlighted in orange).

- |   |                    |   |                          |
|---|--------------------|---|--------------------------|
| 1 | Valve (side view)  | 6 | Adjustment pin           |
| 2 | Bracket            | 7 | Groove                   |
| 3 | Adjustment pin     | 8 | Hole for adjustment pin  |
| 4 | Valve (front view) | 9 | Valve drive (front view) |
| 5 | Bracket            |   |                          |

## 11.8 Exchanging the tubing system

If there is any leakage in the tubing system, try to tighten all connections first. If leaking persists, an exchange of tubing might be required.

Each tube has a specific length and should be exchanged with the corresponding spare part only.

- 1 Run the **Clean** program.
- 2 When **Clean** has been finished, shut down the instrument.
- 3 Switch off and unplug the instrument.
- 4 Loosen the tube connectors of the affected tubing.
- 5 Replace the tubing with the correct part.
- 6 Carefully insert the connector and fasten it by hand. Make sure not to overtighten the screw.
- 7 Plug in and switch on the instrument.
- 8 Run the **Prime** program.
- 9 Run the **Rinse** program and check for leakage.
- 10 Exchange of tubing requires a volume calibration, see chapter **Volume calibration on page 31**.

## 11.9 Preparing for transport

Follow the steps below to prepare the instrument for moving and shipping.

### 1 Go to **Tools > Ready for transport**.

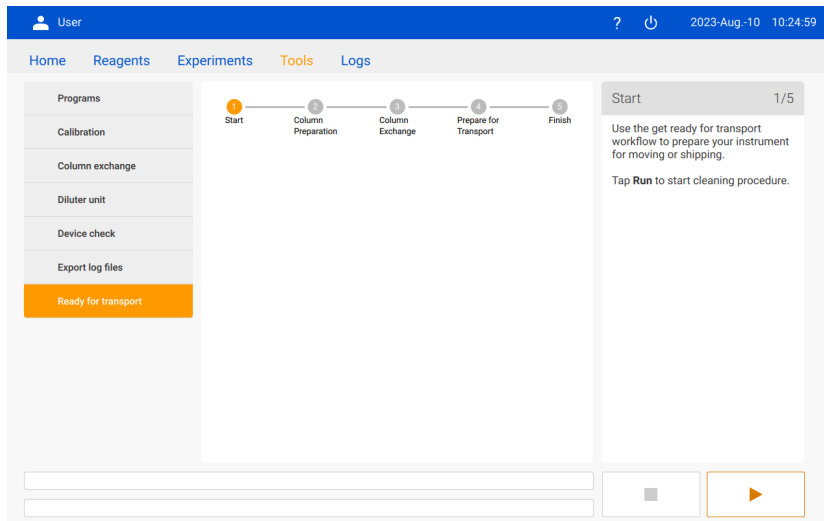

### 2 Tap the **Run** button to start the cleaning procedure. Wait until cleaning is finished.

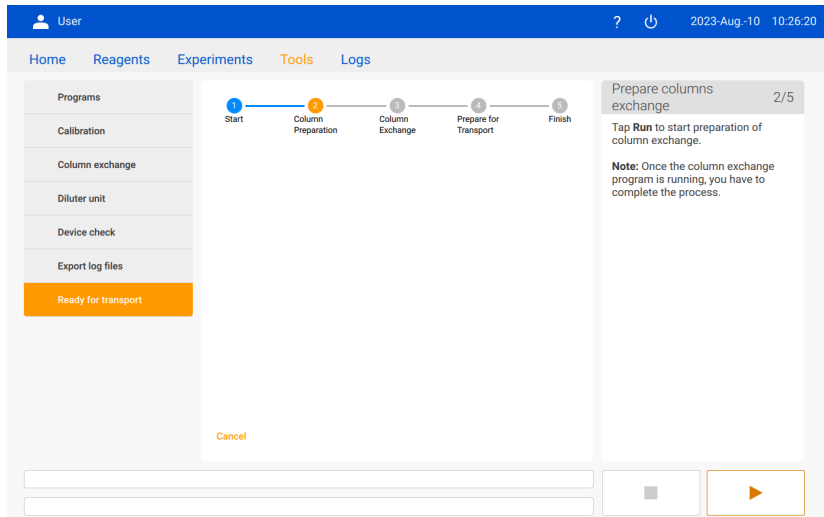

### 3 Optional: If regular autoMACS Columns are installed, the columns have to be replaced by substitutes. Tap the **Run** button to start the column preparation for the column exchange. Wait until the column preparation is finished.

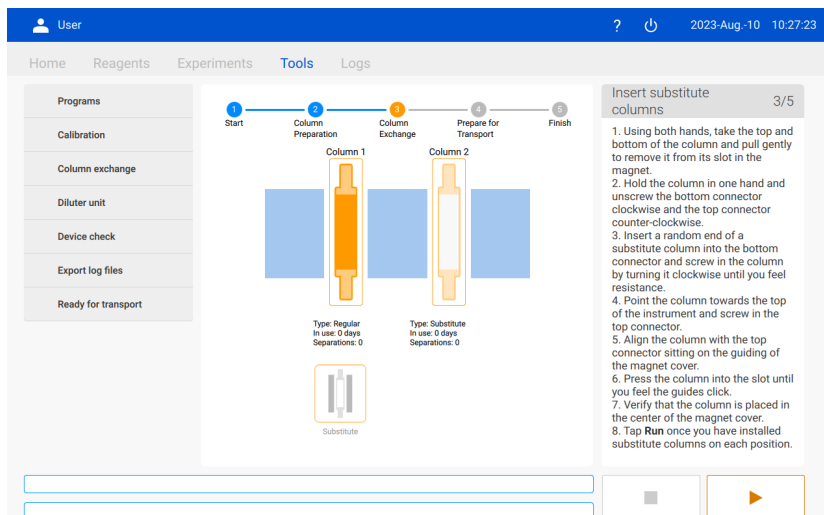

- 4 Optional: Follow the instructions on the screen and install column substitutes in place of regular autoMACS Columns.
- 5 Optional: Tap the **Run** button to finalize the column exchange program. Wait until the column exchange is completed.

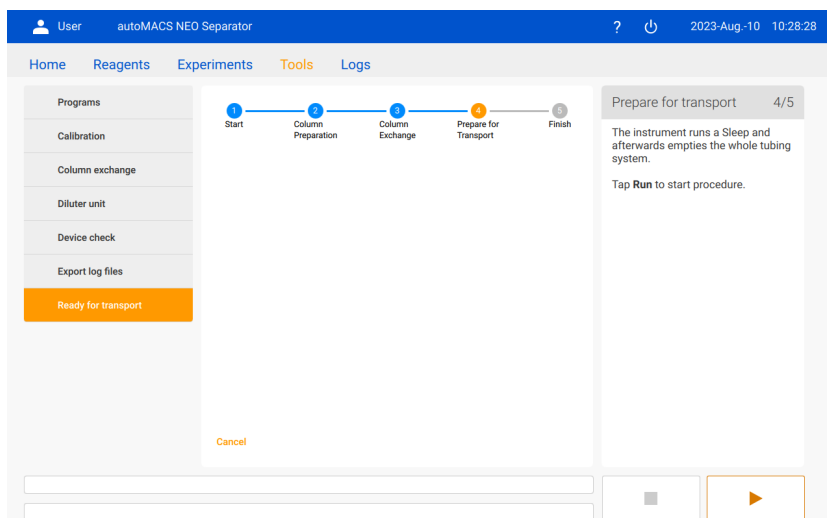

- 6 Tap the **Run** button to prepare the fluidic system for transport. Wait until **Sleep** is finished.

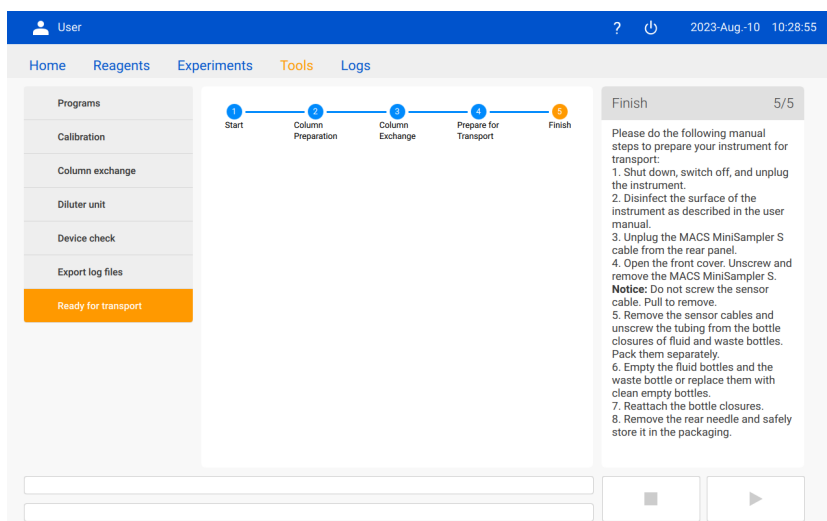

- 7 Shut down, switch off, and unplug the instrument.
- 8 Disinfect the surface of the instrument as described in chapter **Surface disinfection on page 91**.
- 9 Unplug the MACS MiniSampler S cable from the rear panel.
- 10 Open the front cover. Unscrew and remove the MACS MiniSampler S.

**NOTICE: Do not screw the sensor cable. Pull to remove.**

- 11 Remove the sensor cables and unscrew the tubing from the bottle closures of fluid and waste bottles. Pack them separately.
- 12 Empty the fluid bottles and the waste bottle or replace them with clean empty bottles, see chapters **Exchanging empty bottles on page 99** and **Emptying the waste bottle on page 100**.
- 13 Reattach the bottle closures.
- 14 Remove the rear needle and safely store it in the packaging.



# 12

## Troubleshooting

### 12.1 Access to software help

- 1 Tap the **Help** symbol in the title bar. The **Help** menu opens.
- 2 Tap **Help**. The autoMACS NEO Separator user manual opens.

### 12.2 View instrument details

You can find the serial number of your autoMACS NEO Separator and the current software version in the autoMACS NEO Separator user interface.

- 1 Tap the **Help** symbol in the title bar. The **Help** menu opens.
- 2 Tap **About** to open the instrument details.

If you are logged in as administrator, you can alternatively go to **Settings > General settings** to view the instrument details.

### 12.3 Exporting log files

If needed for troubleshooting by Miltenyi Biotec Technical Support, log files can be exported from the instrument to a USB flash drive. The file is exported to the root folder and has the following filename: **amneo\_<serialnumber>\_<UUID>\_YYYY-MM-DD--HH-MM-SS\_journald\_persistent.log.xz**.

- 1 Insert a USB flash drive into one of the USB ports of the touchscreen.
- 2 Go to **Tools > Export log files**.

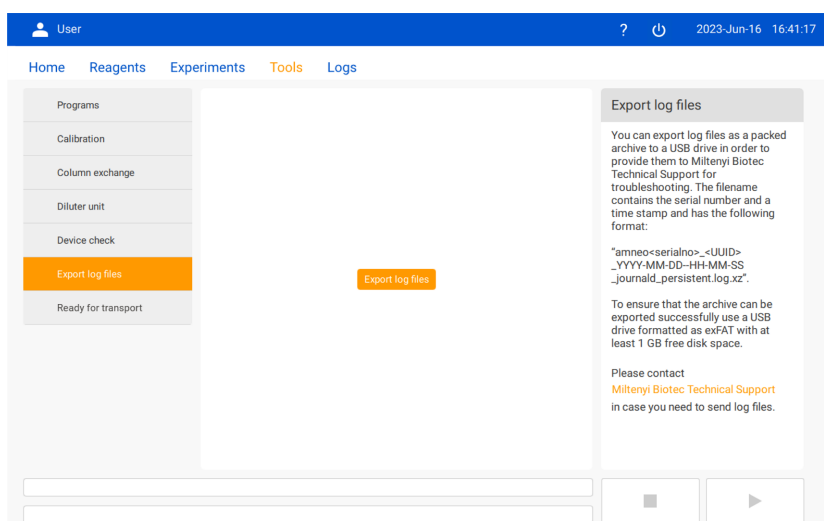

- 3 Tap the button **Export log files**. The export starts immediately. A message box appears that displays the approximate duration of the export.
- 4 Tap **OK** to close the message.

- 5 Wait. A second message box appears when the export has been finished.
- 6 Remove the USB flash drive.

## 12.4 Device check

### **WARNING**

**Defective or inadequate equipment can cause a biological hazard. Contamination or infection may lead to severe personal injury or death, depending on the material used.**

- Do not use the program **Device check** in case of leakage.

The **Device check** is a program that can be run in case of hardware problems. The program checks different hardware components one after the other for correct function. The results help the Miltenyi Biotec Technical Support to find the source of the problem. Start the **Device check** first after being asked to do so by Miltenyi Biotec Technical Support. The LED check and the waste pump check require input of the user. For details regarding these tests, see chapters **LED check on page 115** and **Waste pump check on page 115**.

To start the **Device check**, do the following:

- 1 Go to **Tools > Device check**.
- 2 Select the hardware components that shall be checked or select **Test all** to check all listed components. **Table 12.1** shows the hardware components that can be tested as well as the respective test description.

- 3 Tap **Next** to proceed.

- 4 Confirm that the preconditions are fulfilled if required for the selected check(s).

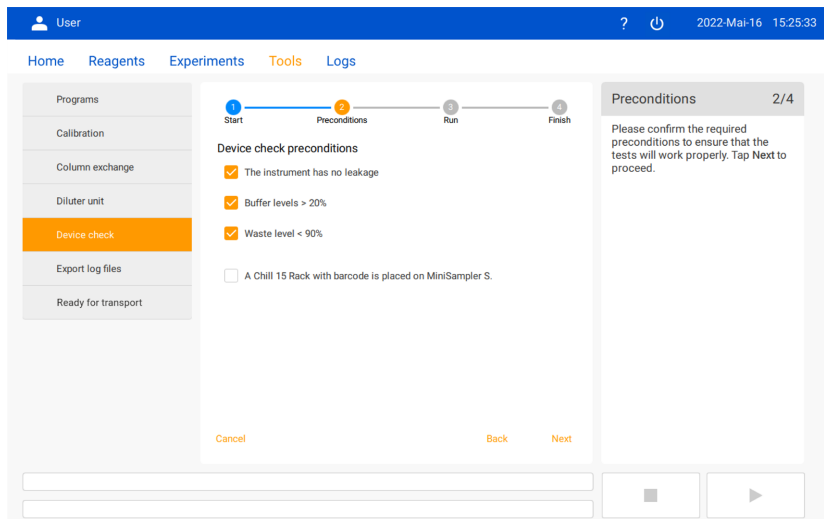

- 5 Tap **Next** to proceed or tap **Cancel** to return to the component selection.

- 6 Tap the **Run** button to start the **Device check**. The test status shown next to the selected hardware component.

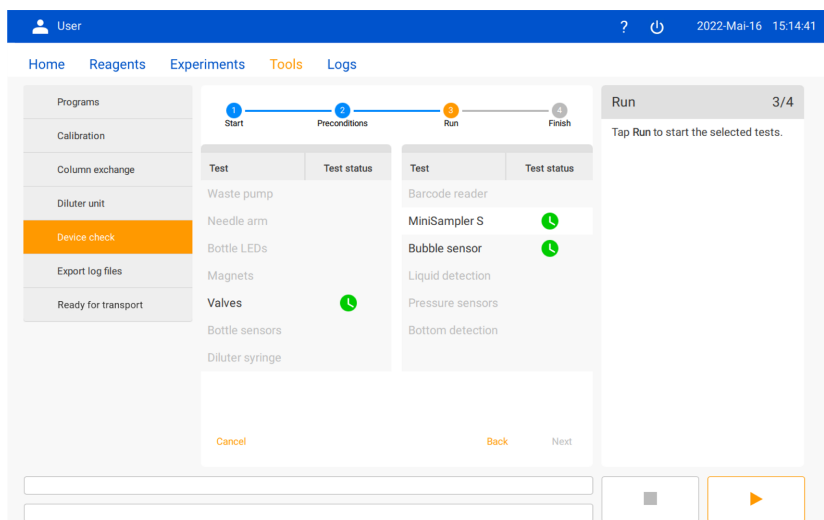

- 7 Wait until the **Device check** is finished. An overview of all test results is shown.

- 8 Optional: Tap a test to open the details of the selected test.

Device check	Description	Preconditions	User input required
<b>Waste pump</b>	Starts the waste pump. The user has to state if he can hear a pumping noise or not.	No	Yes
<b>Bottle LEDs</b>	All bottle LEDs are switched on for 10 seconds one after the other. The user has to state if he can see the bottles lighting up red, green, and blue or not.	No	Yes
<b>Valves</b>	Checks if the top valves and the lower valve are operating correctly.	No	No
<b>Diluter syringe</b>	Checks if the syringe is operating correctly.	No	No
<b>MiniSampler S</b>	Moves the MACS MiniSampler S and checks if it is operating correctly.	No	No
<b>Liquid detection</b>	Moves the robotic needle arm and checks the liquid detection.	The instrument has no leakage. Buffer levels >20 %. Waste levels <90 %.	No
<b>Bottom detection</b>	Moves the robotic needle arm and checks the tube bottom detection.	The instrument has no leakage. Buffer levels >20 %. Waste levels <90 %.	No
<b>Needle arm</b>	Moves the needle arm and checks if it is operating correctly.	No	No
<b>Magnets</b>	Checks if the separation magnets are moving correctly.	No	No
<b>Bottle sensors</b>	Checks if the bottle sensors for the liquid level detection are operating correctly.	No	No
<b>Barcode reader</b>	Positions a Chill 15 Rack in front of the barcode reader and checks if the barcode can be read.	Chill 15 Rack with barcode placed on MACS MiniSampler S.	No
<b>Bubble sensor</b>	Pumps buffer to check if the bubble sensor inside the instrument is operating correctly.	The instrument has no leakage. Buffer levels >20 %. Waste levels <90 %.	No
<b>Pressure sensors</b>	Pumps buffer to check if the pressure sensors inside the instrument are operating correctly.	The instrument has no leakage. Buffer levels >20 %. Waste levels <90 %.	No

**Table 12.1:** Hardware components that can be selected for the **Device check** with test description.

## 12.4.1 Waste pump check

After selection of the waste pump test, the following screen is shown.

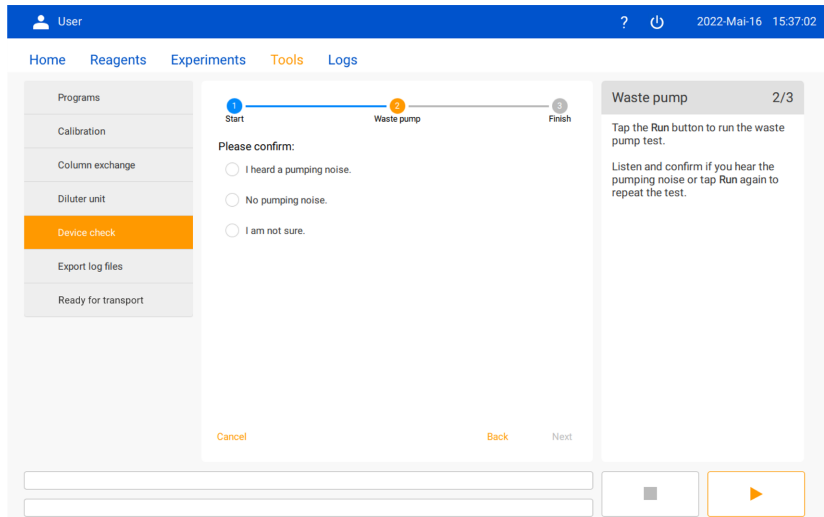

- 1 Tap the **Run** button. The waste pump should start to operate for 5 seconds.
- 2 Listen for the pumping noise.
- 3 Select one of these options in the user interface: **I heard a pumping noise., No pumping noise., I am not sure..**
- 4 Optional: Tap the **Run** button to repeat the test.
- 5 Tap **Next**. The result of the waste pump check is shown.
- 6 Optional: If additional checks have been selected, tap the **Run** button start the next check.

## 12.4.2 LED check

After selection of the LED test, the following screen is shown.

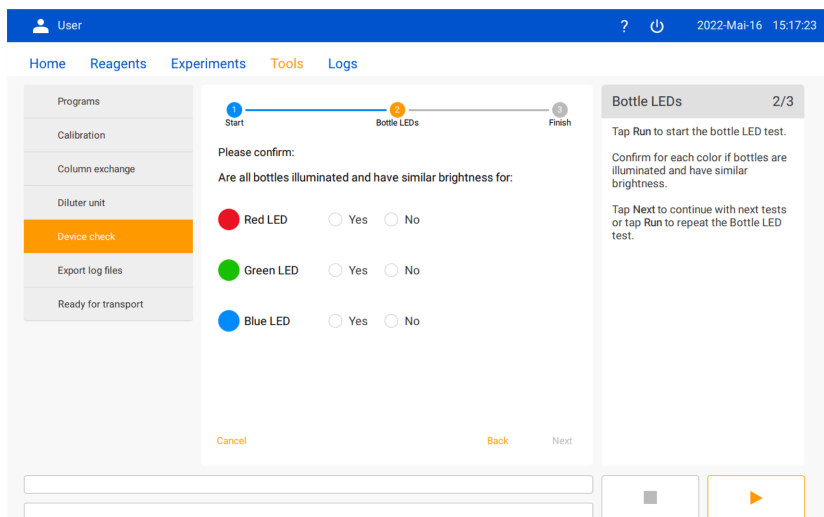

- 1 Tap the **Run** button. The LEDs should start lighting up in the order green, red, blue for 10 seconds respectively.
- 2 During the test observe if all 4 bottles are illuminated in each color and if all bottles are illuminated with the same brightness.
- 3 Confirm with **Yes** if all conditions are fulfilled or reject with **No**.
- 4 Optional: Tap the **Run** button to repeat the test.
- 5 Tap **Next**. The result of the LED check is shown.
- 6 Optional: If additional checks have been selected, tap the **Run** button start the next check.

## 12.5 Disruption of processes

### **WARNING**

**Biohazardous material.**

**Contamination or infection may lead to severe personal injury or death, depending on the material used.**

- Wear personal protective equipment (such as gloves, safety glasses, etc.) as indicated in the safety data sheet for the particular substance.

If a running program or cell separation is disrupted, the instrument turns into the status **Dirty**.

A message box appears that requires a decision on how to proceed depending on the disrupted process and user preferences. **Table 12.2** shows the proceeding options.

In case of an hardware error, try to reinitialize hardware. For details, see chapter **Hardware error on page 118**.

Disrupted process	Proceeding	
<b>A washing program was aborted or disrupted.</b>	The instrument could be reinitialized.	Tap the button <b>Prime</b> in the message box.
	The instrument could not be reinitialized.	Contact Miltenyi Biotec Technical Support.
<b>A cell separation was aborted or disrupted.</b>	The instrument could be reinitialized.	If the sample shall be rescued: Tap the button <b>User manual</b> in the message box and follow rescue procedure, see chapter <b>Cell rescue procedure A on the facing page</b> .
		If the sample shall be discarded: Tap the button <b>Discard sample</b> in the message box.
	The instrument could not be reinitialized.	If the sample shall be rescued: Follow rescue procedure B, see chapter <b>Cell rescue procedure B on the facing page</b> . Contact Miltenyi Biotec Technical Support.
		If the sample shall be discarded: Contact Miltenyi Biotec Technical Support.

**Table 12.2:** Options in case of process disruption.

## 12.5.1 Cell rescue procedure A

Do not run the Sleep program or a wash program to avoid that the cells are flushed into the waste.

- 1 Place a Chill 50 Rack with an empty 50 mL tube onto the MACS MiniSampler S.
- 2 Unscrew the tubing connector of the front needle and place the tubing into a 50 mL tube.
- 3 Take out the rear needle from the needle holder and place the needle into the same 50 mL tube.
- 4 Place a second rack with an empty 50 mL tube next to the waste bottle.
- 5 Disconnect the tubing from the bottle closure of the waste bottle and place it into the second 50 mL tube. If required fix the tubing.
- 6 Tap the **Run** button to start the **Rescue** program. This will rinse the complete fluidic system with autoMACS Running Buffer – MACS Separation Buffer eluting the cells into the 50 mL tubes.
- 7 Centrifuge both tubes at 350×g for 10 minutes.
- 8 Discard the supernatant and apply the cell suspension to a reseparation as soon as possible. Keep cells on ice until the separation.
- 9 Wipe the rear needle and reposition it in the needle holder.
- 10 Reconnect all tubing at the appropriate positions.
- 11 Run a **Rinse** to turn the instrument into the status **Ready**.

## 12.5.2 Cell rescue procedure B

- 1 Switch off the instrument using the power switch on the rear side of the instrument and disconnect the instrument from the power supply.
- 2 Prepare two 50 mL tubes in a rack and fill two 5 mL syringes with luer connector with autoMACS Running Buffer – MACS Separation Buffer.
- 3 Open the front cover and place absorbent tissue underneath the columns.
- 4 Pull out the first column from the column holder and replace the top connector with a 5 mL syringe filled with autoMACS Running Buffer – MACS Separation Buffer.
- 5 Unscrew the bottom connector and flush the column content into a 50 mL tube. Discard the column and syringe.
- 6 Repeat steps 4 to 5 with the second column.
- 7 Centrifuge both tubes at 350×g for 10 minutes.
- 8 Discard the supernatant and perform a reseparation on the recovered cells as soon as possible. Keep cells on ice until the separation.
- 9 Install new autoMACS Columns or column substitutes in place of the discarded columns, see chapter **Exchanging columns on page 101**.
- 10 Contact Miltenyi Biotec Technical Support.

## 12.6 Issues indicated by an error message

If an error occurs, a red message box appears on the upper right side of the screen. Additionally, the fluid bottles are illuminated in red. For color-coding of the message box, see chapter **Messages on page 77**.

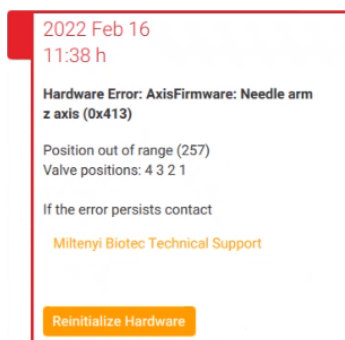

**Figure 12.1:** Example of a message box with error message.

The following information is given in the error message:

- error type: hardware error or process error
- error source (for example hardware module)
- error title
- error ID
- valve positions
- error description and, if applicable, instructions to resolve the error

If a process error occurs, read the instructions in the message box to resolve the problem.

### 12.6.1 Hardware error

In case of a hardware error, the instrument provides the possibility to reinitialize the hardware. Do the following:

- 1 Remove all racks from the MACS MiniSampler S.
- 2 Tap **Reinitialize hardware** in the message box to start the hardware initialization.
- 3 Optional: If necessary, switch off the instrument using the power switch on the rear side of the instrument. Wait for 10 seconds, then switch on the instrument again.

If the problem persists, contact Miltenyi Biotec Technical Support. Have the error ID at hand. See also **Log file analyzer below**.

### 12.6.2 Log file analyzer

The log file analyzer is accessible via **Logs** in the menu bar (**Figure 5.11**). Warnings, error messages, and device check results can be viewed and filtered by date without exporting the whole log file. Use this function when contacting Miltenyi Biotec Technical Support to provide information about recent error messages.

The log file analyzer has the following functions:

- Filter messages in the log file analyzer by date: Tap the date in the filter pane to change the time period.
- Show message details: Tap a message in the list to open the details window.
- Refresh messages list: Tap the **Load recent log messages** button to load new messages.



**⚠ WARNING****Biohazardous material.**

**Contamination or infection may lead to severe personal injury or death, depending on the material used.**

- Wear personal protective equipment (such as gloves, safety glasses, etc.) as indicated in the safety data sheet for the particular substance.
- If hazardous or potentially infectious material has been spilled or leaked from the system, decontaminate the affected area.

Issue	Possible reasons	Solution
<b>Column is leaking.</b>	The column is not inserted precisely into the connector.	<ol style="list-style-type: none"> <li>1 Loosen the column connector.</li> <li>2 Insert the column precisely.</li> </ol>
	The connector is not fastened until point of resistance.	<ol style="list-style-type: none"> <li>3 Tighten the connector again.</li> <li>4 Run the <b>QRinse</b> program.</li> </ol>
	The connectors of the columns are damaged.	<ul style="list-style-type: none"> <li>• Install a new autoMACS Column, see <b>Exchanging columns on page 101</b>.</li> </ul>
<b>Tubing is leaking.</b>	Tubing is not inserted precisely or not tightened properly.	<ol style="list-style-type: none"> <li>1 Shut down, switch off, and unplug the instrument.</li> <li>2 Push the connector to the tube end and screw the connector hand-tight into the port. Tighten the connector carefully to not damage the screw. Do not remove the connector from the tubing.</li> <li>3 Plug in, switch on, and restart the instrument.</li> <li>4 Run the <b>Prime</b> program to check if the leakage persists.</li> </ol>
	The tubing ends are damaged.	<ol style="list-style-type: none"> <li>1 Shut down, switch off, and unplug the instrument.</li> <li>2 Unscrew the tubing and check the ends of the tubing for signs of wear or fissures. Check the screw thread for damages.</li> <li>3 Plug in, switch on, and restart the instrument.</li> <li>4 Run the <b>Prime</b> program to check if the leakage persists.</li> <li>5 If leakage persists, order and install new tubing, see <b>Exchanging the tubing system on page 108</b>.</li> </ol> <p><b>Note: Contact Miltenyi Biotec Technical Support for replacement of the tubing parts. Each tube has a specific length and should be exchanged with the corresponding spare part only.</b></p>
<b>Syringe is filled with air during operation.</b>	Tubing connected to the fluid bottles is not fastened properly or tubing is damaged.	<ul style="list-style-type: none"> <li>• Make sure that all tubing is fastened properly.</li> <li>• If a screw thread is damaged, order and install new tubing.</li> </ul>
	Hydrophobic air filters are clogged.	<ul style="list-style-type: none"> <li>• Check if the hydrophobic air filters connected to the fluid bottles are clogged.</li> <li>• If filters are clogged, replace them with new hydrophobic air filters, see <b>Exchanging hydrophobic air filters on page 100</b>.</li> </ul>

Issue	Possible reasons	Solution
		Clogging may cause positive or negative pressure in the fluid bottles that can lead to pressure problems in the fluidic system.
	Syringe is leaky.	<ul style="list-style-type: none"> <li>Check if syringe is dirty or if the seal is damaged, see <b>Maintaining the syringe (administrators only) on page 102</b>.</li> </ul>
	Rear needle is not connected correctly.	<ul style="list-style-type: none"> <li>Unscrew the rear needle and check the screw threads. If they are undamaged, reinsert precisely and fasten hand-tight.</li> </ul>
<b>Syringe is leaking.</b>	autoMACS Running Buffer – MACS Separation Buffer is not equilibrated to room temperature.	<ul style="list-style-type: none"> <li>Equilibrate autoMACS Running Buffer – MACS Separation Buffer to room temperature.</li> </ul> <p>Cold buffer makes the plunger seal shrink more than the glass cylinder and may lead to leakage.</p>
	Salt crystals may damage the syringe seal.	<ul style="list-style-type: none"> <li>Clean the syringe as described in <b>Maintaining the syringe (administrators only) on page 102</b> and retry.</li> </ul>
<b>Washing station overflows.</b>	Washing station is clogged with salt deposits.	<ol style="list-style-type: none"> <li>Clean the washing station as described in <b>Cleaning the washing station on page 93</b>.</li> <li>Run the <b>Rinse</b> program.</li> </ol> <p>To prevent the formation of salt deposits, wipe the outlet ports with a tissue soaked with distilled or deionized water before each <b>Sleep</b> program.</p>
<b>Instrument is contaminated.</b>		<ul style="list-style-type: none"> <li>Disinfect the instrument as described in <b>Disinfection of the fluidic system on page 91</b>.</li> <li>Ensure to run a <b>Sleep</b> program before each shutdown to prevent contamination of the instrument.</li> </ul>
<b>MACS MiniSampler S does not move as intended.</b>		<ul style="list-style-type: none"> <li>See troubleshooting in the MACS MiniSampler S user manual.</li> </ul>
<b>Touchscreen remains dark.</b>	Software issue.	<ol style="list-style-type: none"> <li>Switch off the instrument and wait for 10 seconds.</li> <li>Switch on the instrument again.</li> <li>Tap the touchscreen to power up the software.</li> </ol>
	The power cable is not plugged in correctly.	<ol style="list-style-type: none"> <li>Switch off the instrument.</li> <li>Plug in the power cable.</li> <li>Switch on the instrument again.</li> </ol>

**Table 12.3:** Troubleshooting for the autoMACS NEO Separator.

If the problem persists or if you need assistance, contact Miltenyi Biotec Technical Support.

# 13

## Technical data and specifications

The autoMACS NEO Separator is labeled as a protection class I device and must be plugged into a grounded power outlet.

Transient overvoltages present on the mains supply: category II. Supply voltage fluctuations up to +/- 10% of the nominal voltage. The instrument is suitable for rated pollution degree 2.

The instrument has been designed for a lifetime of 10 years.

For other safety considerations, refer to the product label or visit [www.miltenyibiotec.com](http://www.miltenyibiotec.com).

Design and specifications are subject to change without notice.

### 13.1 FCC compliance statement

This device complies with part 15 of the FCC Rules. Operation is subject to the following two conditions:

- 1 This device may not cause harmful interference, and
- 2 this device must accept any interference received, including interference that may cause undesired operation.

Changes or modifications of the instrument, unless expressly approved by Miltenyi Biotec B.V. & Co. KG, may void the authority to operate the instrument pursuant to FCC 47 CFR.

Note:

This equipment has been tested and found to comply with the limits for a Class B digital device, pursuant to Part 15 of the FCC Rules.

These limits are designed to provide reasonable protection against harmful interference in a residential installation.

This equipment generates, uses, and can radiate radio frequency energy and, if not installed and used in accordance with the instructions, may cause harmful interference to radio communications. However, there is no guarantee that interference will not occur in a particular installation.

If this equipment does cause harmful interference to radio or television reception, which can be determined by turning the equipment off and on, the user is encouraged to try to correct the interference by one or more of the following measures:

- Reorient or relocate the receiving antenna.
- Increase the distance between the equipment and the receiver.
- Connect the equipment to an outlet on a circuit different from that to which the receiver is connected.
- Consult the dealer or an experienced radio/TV technician for help.

## 13.2 Technical data

Technical data	Specification
Model	autoMACS NEO Separator
Order number	130-120-327
Footprint (w x d)	387 mm x 289 mm (15.2" x 11.4")
Footprint with accessory (w x d)	438 mm x 454 mm (17.2" x 17.9")
Dimensions (w x d)	605 mm x 384 mm (23.8" x 15.1")
Dimensions with accessory (w x d)	633 mm x 491 mm (24.9" x 19.3")
Dimensions with all covers open (w x d)	819 mm x 610 mm (32.2" x 24.0")
Dimensions with accessory with all covers open (w x d)	824 mm x 610 mm (32.4" x 24.0")
Height	395 mm–500 mm (15.6"–19.7") (adjustable touchscreen)
Weight	31 kg
Input voltage	100–240 V~, 50/60 Hz
Maximum power consumption	200 W
Average power consumption	50 W
Fuses	2 x T4A, 250 V
Working temperature	+15 to +30 °C
Storage temperature	Room temperature; avoid condensing conditions
Humidity	20% to 80% relative humidity, non-condensing
Altitude	max. 2000 m
Emission sound pressure level at workstation	<70 dB(A)
USB ports	2 x USB 2.0 ports (rear panel) 2 x USB 3.0 ports (display)
Additional ports	RS232 Interface (labeled COM) Ethernet Interface (labeled LAN) CAN Bus + DC Output (labeled Power CAN) Bottle Sensor Interface (labeled Bottle Sensor) For service only: CAN-Bus + DC-Output (labeled CAN)
RAM	4 GB
Mass storage	SSD, 64 GB
Monitor	10.1" LCD touchscreen
Pipetting volume range	0.02–50 mL
Uptake flow rate	0.25–8 mL/min
Liquids	autoMACS Washing Solution autoMACS Running Buffer – MACS Separation Buffer Storage solution (70% Ethanol) Bleach solution (1% Sodium hypochlorite solution)

**Table 13.1:** Technical data of the autoMACS NEO Separator.

### 13.3 EC/EU Declaration of Conformity

This declaration of conformity is issued under the sole responsibility of the manufacturer:

Miltenyi Biotec B.V. & Co. KG  
Friedrich-Ebert-Straße 68  
51429 Bergisch Gladbach  
Germany

This declaration relates exclusively to the machinery in the state in which it was placed on the market, and excludes components which are added and/or operations carried out subsequently by the final user.

The declaration of conformity refers to the product identified as follows:

Description: Laboratory equipment  
Model: autoMACS NEO Separator

The machinery complies with all essential requirements of the following directives:

2006/42/EC Machinery  
2011/65/EU Restriction of the use of certain hazardous substances in electrical & electronic equipment  
2014/30/EU Electromagnetic compatibility

The machinery is in conformity with the following harmonized standards:

EN 61010-1:2010  
EN 61010-2-081:2015  
EN 61326-1:2013

Person authorized to compile the relevant technical documentation:

Dr. Bernd Schröder  
Global Head Regulatory Affairs  
Miltenyi Biotec B.V. & Co. KG  
Friedrich-Ebert-Straße 68  
51429 Bergisch Gladbach  
Germany

## 13.4 UK Declaration of Conformity

This declaration of conformity is issued under the sole responsibility of the manufacturer:

Miltenyi Biotec B.V. & Co. KG  
Friedrich-Ebert-Straße 68  
51429 Bergisch Gladbach  
Germany

This declaration relates exclusively to the machinery in the state in which it was placed on the market, and excludes components which are added and/or operations carried out subsequently by the final user.

The declaration of conformity refers to the product identified as follows:

Description: Laboratory equipment  
Model: autoMACS NEO Separator

The machinery complies with all essential requirements of the following legislations:

Supply of Machinery (Safety) Regulations 2008  
The Restriction of the Use of Certain Hazardous Substances in Electrical and Electronic Equipment Regulations 2012  
Electromagnetic Compatibility Regulations 2016

The machinery is in conformity with the following UK designated standards:

EN 61010-1:2010  
EN 61010-2-081:2015  
EN 61326-1:2013

Person authorized to compile the relevant technical documentation:

Dr. Bernd Schröder  
Global Head Regulatory Affairs  
Miltenyi Biotec B.V. & Co. KG  
Friedrich-Ebert-Straße 68  
51429 Bergisch Gladbach  
Germany

# 14

## Technical support

For technical support, contact your local Miltenyi Biotec representative or Miltenyi Biotec Technical Support at Miltenyi Biotec headquarters:

Miltenyi Biotec B.V. & Co. KG  
Friedrich-Ebert-Straße 68  
51429 Bergisch Gladbach  
Germany  
Phone: +49 2204 8306 3803  
Email: [technicalsupport@miltenyi.com](mailto:technicalsupport@miltenyi.com)

Visit [www.miltenyibiotec.com](http://www.miltenyibiotec.com) for local Miltenyi Biotec Technical Support contact information.





# 15

## Legal notes

### 15.1 Limited warranty

Except as stated in a specific warranty statement which may accompany this product or as otherwise agreed in writing by an authorized representative of Miltenyi Biotec, Miltenyi Biotec's warranty to you, the original purchaser and end user ("you" or "your"), with respect to the product accompanied by this limited warranty shall be subject to the following provisions and the general terms and conditions of sale of the company within the Miltenyi Biotec group which supplied the product in effect at the date of purchase. Those terms and conditions of sale may vary by country and region. Nothing in this document should be construed as constituting an additional warranty.

Miltenyi Biotec warrants that this product will operate or perform substantially in conformance with Miltenyi Biotec's published specifications and be free from material defects in material and workmanship, when subjected to normal, proper, and intended usage by properly trained personnel, for the period of time set forth in the product documentation or package inserts accompanying the product (the "Warranty Period").

Miltenyi Biotec agrees, during the Warranty Period, to repair or replace, at Miltenyi Biotec's option, the defective product so as to cause the same to operate in substantial conformance with said published specifications; provided that you shall (a) promptly notify Miltenyi Biotec in writing upon the discovery of any nonconformity or defect, which notice shall include the product model and serial number (if applicable) and details of the warranty claim; and (b) return the nonconforming or defective product to Miltenyi Biotec, freight prepaid, only after receipt of a Return Material Authorization ("RMA") from Miltenyi Biotec, which may include biohazard decontamination procedures and other product-specific handling instructions, if applicable.

Miltenyi Biotec shall have no obligation to make repairs, replacements, or corrections to the product or any component thereof required, in whole or in part, as the result of (i) normal wear and tear, (ii) improper handling, installation, operation, storage, service, maintenance, or repair, (iii) failure to follow the instructions, cautions, warnings, and notes set forth in the product documentation provided with the product or provided by Miltenyi Biotec from time to time, (iv) abnormal use, misuse, neglect, abuse, mishandling, misapplication, modification, or alteration of the product, (v) use of the product in a manner for which it was not designed, (vi) causes external to the product such as, but not limited to, power failure or electrical power surges, (vii) use of the product in combination with equipment, accessories, consumables, or software not supplied or approved by Miltenyi Biotec, or (viii) accident, disaster, or acts of God. ANY INSTALLATION, MAINTENANCE, REPAIR, SERVICE, OR ALTERATION TO OR OF, OR OTHER TAMPERING WITH, THE PRODUCT PERFORMED BY ANY PERSON OR ENTITY OTHER THAN MILTENYI BIOTEC AUTHORIZED PERSONNEL WITHOUT MILTENYI BIOTEC'S PRIOR WRITTEN APPROVAL, OR ANY USE OF REPLACEMENT PARTS NOT SUPPLIED BY MILTENYI BIOTEC, SHALL IMMEDIATELY VOID AND CANCEL ALL WARRANTIES WITH RESPECT TO THE AFFECTED PRODUCT.

Miltenyi Biotec's warranty does not cover products sold AS IS or WITH ALL FAULTS, or which had its serial number defaced, altered, or removed, or any consumables or parts identified as being supplied by a third party.

Miltenyi Biotec must be informed promptly if a claim is made under this limited warranty. If a material or manufacturing defect occurs within the Warranty Period, Miltenyi Biotec will take the appropriate steps, at Miltenyi Biotec's option, to make repairs, replacements, or corrections to the product or any component thereof as may be required to restore the full usability of your product. If Miltenyi Biotec determines that a product for which you have requested warranty services is not covered by the warranty hereunder, you shall pay or reimburse Miltenyi Biotec for all costs of investigating and responding to such request at Miltenyi Biotec's then prevailing time and materials rates. If Miltenyi Biotec provides repair services or replacement parts that are not covered by this warranty, you shall pay Miltenyi Biotec therefor at Miltenyi Biotec's then prevailing time and materials rates.

THE OBLIGATIONS CREATED BY THIS WARRANTY STATEMENT TO REPAIR OR REPLACE A DEFECTIVE PRODUCT ARE EXCLUSIVE AND SHALL BE THE SOLE REMEDY OF BUYER IN THE EVENT OF A DEFECTIVE PRODUCT. EXCEPT AS EXPRESSLY PROVIDED IN THIS WARRANTY STATEMENT, MILTENYI BIOTEC HEREBY DISCLAIMS ALL OTHER WARRANTIES, WHETHER EXPRESS OR IMPLIED, ORAL OR WRITTEN, WITH RESPECT TO THE PRODUCT, INCLUDING WITHOUT LIMITATION ALL IMPLIED WARRANTIES OF MERCHANTABILITY OR FITNESS FOR ANY PARTICULAR PURPOSE. MILTENYI BIOTEC DOES NOT WARRANT THAT THE PRODUCT IS ERROR-FREE OR WILL ACCOMPLISH ANY PARTICULAR RESULT.

UNDER NO CIRCUMSTANCES WILL MILTENYI BIOTEC BE LIABLE FOR ANY LOSS OF USE, INTERRUPTION OF BUSINESS, OR ANY INDIRECT, SPECIAL, INCIDENTAL, PUNITIVE, OR CONSEQUENTIAL DAMAGES OF ANY KIND (INCLUDING LOST PROFITS) REGARDLESS OF THE FORM OF ACTION WHETHER IN CONTRACT, TORT (INCLUDING NEGLIGENCE), STRICT PRODUCT LIABILITY, OR OTHERWISE, EVEN IF MILTENYI BIOTEC HAS BEEN ADVISED OF THE POSSIBILITY OF SUCH DAMAGES. IN NO EVENT SHALL THE TOTAL LIABILITY OF MILTENYI BIOTEC HEREUNDER EXCEED THE GREATER OF 100.00 EUROS OR THE AMOUNT YOU ACTUALLY PAID FOR THE PRODUCT GIVING RISE TO SUCH LIABILITY, REGARDLESS OF THE CAUSE OF ACTION, IN CONTRACT, TORT, STRICT LIABILITY, OR OTHERWISE.

NOT ALL JURISDICTIONS ALLOW SUCH LIMITATIONS OF DAMAGES SO THE FOREGOING LIMITATIONS MAY NOT APPLY TO YOU. This warranty statement gives you specific legal rights and you may have other rights, which may vary from jurisdiction to jurisdiction.

## 15.2 Trademarks

autoMACS, MACS, the Miltenyi Biotec logo, and REAlease are registered trademarks or trademarks of Miltenyi Biotec B.V. & Co. KG and/or its affiliates in various countries worldwide.





## Miltenyi Biotec

### Germany/Austria

Miltenyi Biotec B.V. & Co. KG  
Friedrich-Ebert-Straße 68  
51429 Bergisch Gladbach  
Germany  
Phone +49 2204 8306-0  
Fax +49 2204 85197  
macsde@miltenyi.com

### USA/Canada

Miltenyi Biotec Inc.  
2303 Lindbergh Street  
Auburn, CA 95602, USA  
Phone 800 FOR MACS  
Phone +1 866 811 4466  
Fax +1 877 591 1060  
macsus@miltenyi.com

### Australia

Miltenyi Biotec  
Australia Pty. Ltd.  
Unit 11, 2 Eden Park Drive  
Macquarie Park NSW 2113  
Australia  
Phone +61 2 8877 7400  
Fax +61 2 9889 5044  
macsau@miltenyi.com

### Benelux

Miltenyi Biotec B.V.  
Dellaertweg 9C  
2316 WZ Leiden  
The Netherlands  
macsnl@miltenyi.com

### Customer service

**The Netherlands**  
Phone 0800 4020120  
Fax 0800 4020100

### Customer service Belgium

Phone 0800 94016  
Fax 0800 99626

### Customer service Luxembourg

Phone 800 24971  
Fax 800 24984

### China

Miltenyi Biotec Technology &  
Trading (Shanghai) Co., Ltd.  
Room A401, 4/F  
No. 1077, Zhangheng Road  
Pudong New Area  
201203 Shanghai, P.R. China  
Phone +86 21 6235 1005-0  
Fax +86 21 6235 0953  
macscn@miltenyi.com.cn

### France

Miltenyi Biotec SAS  
10 rue Mercoeur  
75011 Paris, France  
Phone +33 1 56 98 16 16  
macsfr@miltenyi.com

### Hong Kong

Miltenyi Biotec Hong Kong Ltd.  
Unit 301, Lakeside 1  
No. 8 Science Park West Avenue  
Hong Kong Science Park  
Pak Shek Kok, New Territories  
Hong Kong  
Phone +852 3751 6698  
Fax +852 3619 5772  
macshk@miltenyi.com.hk

### Italy

Miltenyi Biotec S.r.l.  
Via Paolo Nanni Costa, 30  
40133 Bologna  
Italy  
Phone +39 051 6 460 411  
Fax +39 051 6 460 499  
macsit@miltenyi.com

### Japan

Miltenyi Biotec K.K.  
NEX-Eitai Building 5F  
16-10 Fuyuki, Koto-ku,  
Tokyo 135-0041, Japan  
Phone +81 3 5646 8910  
Fax +81 3 5646 8911  
macsjp@miltenyi.com

### Nordics and Baltics

Miltenyi Biotec Norden AB  
Medicon Village  
Scheeletorget 1  
223 81 Lund  
Sweden

macsse@miltenyi.com

### Customer service Sweden

Phone 0200 111 800  
Fax +46 280 72 99

### Customer service Denmark

Phone 80 20 30 10  
Fax +46 46 280 72 99

### Customer service

**Norway, Finland, Iceland  
and Baltic countries**  
Phone +46 46 280 72 80  
Fax +46 46 280 72 99

### Singapore

Miltenyi Biotec Asia Pacific Pte Ltd  
438B Alexandra Road, Block B  
Alexandra Technopark  
#06-01  
Singapore 119968  
Phone +65 6238 8183  
Fax +65 6238 0302  
macssg@miltenyi.com

### South Korea

Miltenyi Biotec Korea Co., Ltd.  
Donggeuk 7F,  
562 Nonhyeon-ro  
Gangnam-gu  
Seoul 06136, South Korea  
Phone +82 2 555 1988  
Fax +82 2 555 8890  
macskr@miltenyi.com

### Spain

Miltenyi Biotec S.L.  
C/Luis Buñuel 2  
Ciudad de la Imagen  
28223 Pozuelo de Alarcón  
(Madrid)  
Spain  
Phone +34 91 512 12 90  
Fax +34 91 512 12 91  
macses@miltenyi.com

### Switzerland

Miltenyi Biotec Swiss AG  
Gibelinstrasse 27  
4500 Solothurn  
Switzerland  
Phone +41 32 623 08 47  
Fax +49 2204 85197  
macsch@miltenyi.com

### United Kingdom

Miltenyi Biotec Ltd.  
Almac House, Church Lane  
Bisley, Surrey GU24 9DR, UK  
Phone +44 1483 799 800  
Fax +44 1483 799 811  
macsuk@miltenyi.com

[www.miltenyibiotec.com](http://www.miltenyibiotec.com)

Miltenyi Biotec provides products and services worldwide. Visit [www.miltenyibiotec.com/local](http://www.miltenyibiotec.com/local) to find your nearest Miltenyi Biotec contact.

Unless otherwise specifically indicated, Miltenyi Biotec products and services are for research use only and not for therapeutic or diagnostic use. autoMACS, MACS, the Miltenyi Biotec logo, and REAlease are registered trademarks or trademarks of Miltenyi Biotec B.V. & Co. KG and/or its affiliates in various countries worldwide. Copyright © 2023 Miltenyi Biotec and/or its affiliates. All rights reserved.